

AT2618MF	Important safety instructions	3
AT3218MF	Disposal instructions	4
AT2628ML	Your LCD TV overview	5
AT3228ML	Front and side panels	5
AT4028ML	Rear panel view	6
	Side AV label view	7
	Remote control	8
	General keys	8
	Teletext and Multimedia	9
	Basic connections	10
	Connecting the power cord	10
	Setting up the remote control	10
	Enjoying analog and digital TV	10
	Connecting an antenna/cable	10
	Getting started watching your TV	11
	Wall mount preparation / removing the base	12
	Connecting external audio/video devices	13
	Connecting a DVD, VCR, STB or audio/video equipment	13
	Connecting a camera, camcorder or game console	14
	Connecting a PC or notebook computer	15
	Connecting a USB storage device	15
	Selecting the input source	16
	Playing multimedia files from a USB storage device	17
	Connecting a USB storage device	17
	Navigating in the multimedia screen	17
	Channel controls	20
	Channel list	20
	Favourite channel list	21
	Programme information	22
	Electronic programme guide	22
	OSD navigation	24
	Navigating the OSD with the remote control	24
	Adjusting the OSD settings	25
	OSD menus	27
	Picture settings	27
	Sound settings	28
	PAP function	29
	Options settings	29
	Timer settings	31
	Lock settings	31
	Setup the TV	32
	Special functions	34
	Troubleshooting	35
	PC Input Signal Reference Chart	36
	Product specifications	37



User Guide

Model Number: _____

Serial Number: _____

Purchase Date: _____

Place of Purchase: _____

	HDMI, the HDMI logo and High-Definition Multimedia Interface are trademarks or registered trademarks of HDMI Licensing LLC.
	DVB is a registered trademark of the DVB Project.

Important safety instructions

Read these instructions carefully. Please put them somewhere safe for future reference.

1. Only use attachments/accessories specified by the manufacturer.
2. Use only with the cart, stand, tripod, bracket, or table specified by the manufacturer, or sold with the apparatus. When a cart is used, use caution when moving the cart/ apparatus combination to avoid injury from tip-over.
3. Unplug this apparatus during lightning storms or when unused for long periods of time.
4. Do not install this equipment in a confined space such a book case or similar unit.



5.  **WARNING**
To prevent the spread of fire, keep candles or other open flames away from this apparatus at all times.
6. If the remote control will not to be used for a long time, remove the batteries. Use the remote control carefully. Do not drop the remote control on the floor. Keep it away from moisture, direct sunlight, and high temperatures.
7. Batteries shall not be exposed to excessive heat from sunshine, fire or other heat sources. Used or discharged batteries must be properly disposed of or recycled in compliance with all applicable laws. For detailed information, contact your local solid waste disposal authority.
8. Follow all warnings and instructions marked on the product.
9. Unplug this product from the wall outlet before cleaning. Do not use liquid cleaners or aerosol cleaners. Use a damp cloth for cleaning.
10. The apparatus shall not be exposed to drips or splashes. No objects filled with liquids, such as vases, shall be placed on the apparatus.
11. Do not place this product on an unstable cart, stand or table. The product may fall, sustaining serious damage.
12. Slots and openings are provided for ventilation; to ensure reliable operation of the product and to protect it from overheating, these openings must not be blocked or covered. The openings should never be blocked by placing the product on a bed, sofa, rug or other similar surface. This product should never be placed near or over a radiator or heat register or in a built-in installation unless proper ventilation is provided.
13. This product should be operated from the type of power indicated on the marking label. If you are not sure of the type of power available, consult your dealer or local power company.
14. Do not allow anything to rest on the power cord. Do not locate this product where the cord will be stepped on.
15. If an extension cord is used with this product, make sure that the total ampere rating of the equipment plugged into the extension cord does not exceed the extension cord ampere rating. Also, make sure that the total rating of all products plugged into the wall outlet does not exceed the fuse rating.
16. Never push objects of any kind into this product through cabinet slots as they may touch dangerous voltage points or short-out parts, which could result in a fire or electric shock. Never spill liquid of any kind on the product.
17. Do not attempt to service this product yourself, as opening or removing covers may expose you to dangerous voltage points or other risks. Refer all servicing to qualified service personnel.
18. Unplug this product from the wall outlet and refer servicing to qualified service

personnel under the following conditions:

- a. When the power cord or plug is damaged or frayed.
 - b. If liquid has been spilled into the product.
 - c. If the product has been exposed to rain or water.
 - d. If the product does not operate normally when the operating instructions are followed. Adjust only those controls that are covered by the operating instructions. Improper adjustment of other controls could result in damage; extensive work by a qualified technician might then be required to restore the product to normal condition.
 - e. If the product has been dropped or the case has been damaged.
 - f. If the product exhibits a distinct change in performance, indicating a need for service.
19. Use only the proper type of power supply cord set (provided in your accessories box) for this unit. Always disconnect the power cord from the wall outlet before servicing or disassembling this equipment.
 20. Do not overload an electrical AC outlet, power strip, or convenience receptacle. The overall system load must not exceed 80% of the branch circuit rating. If power strips are used, the load should not exceed 80% of the power strip input rating.
 21. Some products are equipped with a three-wire electrical grounding-type plug that has a third pin for grounding. This plug only fits into a grounded electrical outlet. This is a safety feature. Make sure the AC outlet is properly grounded. Do not defeat the safety purpose of the grounding-type plug by trying to insert it into a non-grounded outlet. If you cannot insert the plug into the outlet, contact your electrician to replace the obsolete outlet.
 22. Do not use this LCD TV in the workplace in accordance with BildscharbV, and maintain ample distance from it when watching. Watching a big-screen TV too close can cause eyestrain.
 23. This TV is designed for home entertainment purposes only. Make sure there is sufficient distance between you and the TV when you are viewing content to avoid harming your eyes.
 24. Where the mains plug or power cable is used to disconnect power, the cable or plugs shall remain readily accessible.



The grounding pin is an important safety feature. It is possible to receive an electric shock from a system that is not properly grounded.



The grounding pin is also providing good immunity ability against unexpected noise that interferes performance of this product and is produced by other nearby electrical devices.

Disposal instructions

Do not throw this electronic device into the rubbish bin / container when discarding. To minimize pollution and ensure utmost protection of the global environment, please recycle.



For more information regarding WEEE, please refer to <http://global.acer.com/about/environmental.htm>

Соответствует сертификатам, обязательным в РФ
(Compliant with Russian regulatory certification)



UA.TR.002



ME61

Your LCD TV overview

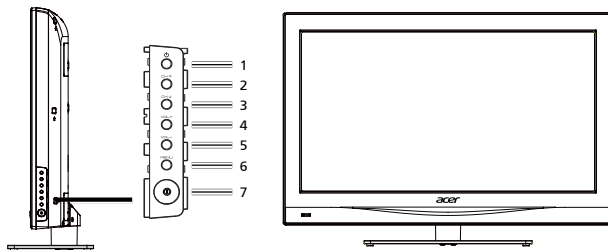

Front and side panels (AT2618MF/AT3218MF)

1	Standby	Turns the TV ON and OFF.
2	Channel up	When the OSD is on, functions the same as the Up arrow.
3	Channel down	When the OSD is on, functions the same as the Down arrow.
4	Volume up	When the OSD is on, functions the same as the Right arrow.
5	Volume down	When the OSD is on, functions the same as the Left arrow.
6	Menu key	Turns the OSD menu ON and OFF.
7	AC power button	Turns the power ON and OFF.

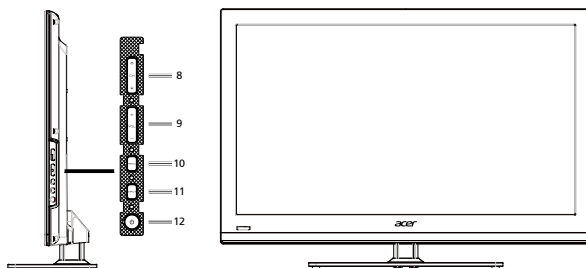

Front and side panels (AT2628ML/AT3228ML/AT4028ML)

8	Channel up/down	When the OSD is on, functions the same as the Up/Down arrow.
9	Volume up/down	When the OSD is on, functions the same as the Right/Left arrow.
10	Menu key	Turns the OSD menu ON and OFF.
11	Input	When the OSD is on, functions the same as the OK key.
12	Standby	Turns the TV ON and OFF.

Rear panel view (AT2618MF/AT3218MF/AT2628ML)

1	AV (SCART)	5	PC Audio L/R
2	COMPONENT-in + Audio-in L/R	6	HDMI 2 port
3	VGA-in	7	Antenna/Cable-in
4	SPDIF out		

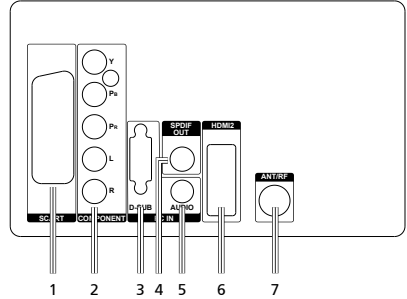
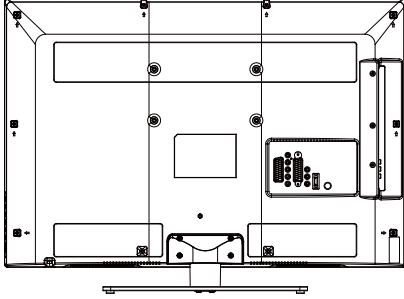

Rear panel view (AT3228ML/AT4028ML)

8	COMPONENT-in + Audio-in L/R	11	Antenna/Cable-in
9	PC Audio L/R	12	VGA-in
10	AV (SCART)		

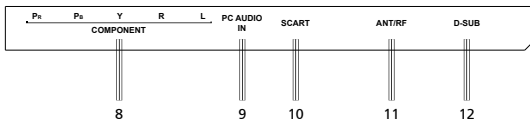
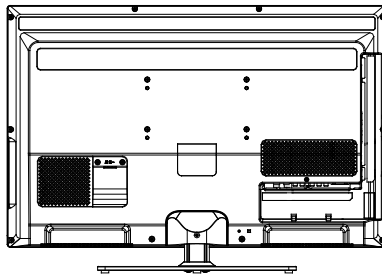

Side AV label view (AT2618MF/AT3218MF/AT2628ML)

1	Common interface	3	USB port
2	HDMI1 port	4	Earphone

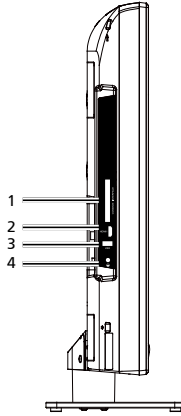

Side AV label view (AT3228ML/AT4028ML)

5	SPDIF out	9	HDMI2 port
6	Earphone	10	HDMI3 port
7	Common interface	11	USB port
8	HDMI1 port		

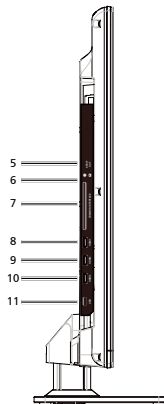

Remote control

General keys

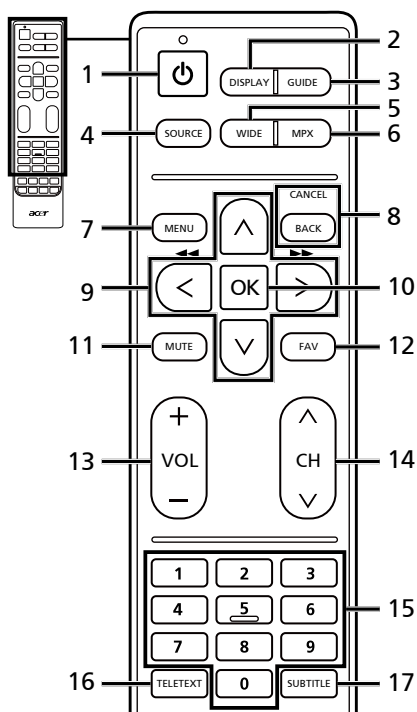

- 1 **POWER**
Press to turn your TV on/off.
- 2 **DISPLAY**
Press to display channel information (dependent on input/source type).
- 3 **GUIDE**
Press to launch Electronic Programme Guide (EPG) mode (Digital TV mode only). See page 22.
- 4 **SOURCE**
Press to display the Source menu.
- 5 **WIDE**
Press to toggle scaling mode between Cinerama, 14:9 Zoom, 16:9 Zoom, 16:9 Zoom up, Wide Zoom, Zoom 2, 16:9 format and 4:3 format modes.
- 6 **MPX**
Press to select a sound type available for the selected analogue TV programme; to select an audio language available for the selected digital TV programme.
- 7 **MENU**
Press to open the Menu.
Press to back to the previous menu.
- 8 **BACK/CANCEL**
Press to close the Menu.
Press to exit some operations.
Press to go back to the previously viewed channel.
- 9 **Directional keys**
In menu operation, press the up/down directional keys to select a certain option and press the left and right directional keys to adjust.
- 10 **OK/ENTER/CH LIST**
ENTER: Press to confirm a selection.
CH LIST: Press to launch the channel list. See page 20.
- 11 **MUTE**
Press to toggle audio on and off.
- 12 **FAV**
Press to display the favorite channel list.
- 13 **VOL (+/-)**
Press to increase or decrease the volume.
- 14 **CH (up/down)**
Press to sequentially select the TV channel and other source input.
- 15 **Number keys**
- 16 **TELETEXT**
Press to switch from TV/AV to Teletext mode.
Press again to overlay teletext page on the TV image.
- 17 **SUBTITLE**
Press to select a subtitle language available for the selected digital TV programme.

Teletext and Multimedia

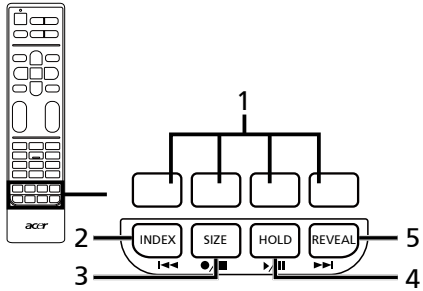

Teletext

- 1 **Colour buttons (R/G/Y/B)**
Operates corresponding button on the teletext page.
- 2 **INDEX**
No function.
- 3 **SIZE**
Press once to zoom teletext page to 2X and view the top part.
Press twice to view the bottom part of 2X teletext page.
Press again to resume.
- 4 **HOLD**
Press to pause the current teletext page.
- 5 **REVEAL**
Press to reveal hidden teletext information.

Multimedia

- 2 **Previous Track**
Press to go to the beginning of a track, or the previous track.
- 3 **Stop**
Press to stop playback.
- 4 **Play/Pause**
Press to start playing the selected track, or pause a track if it is already playing.
- 5 **Next track**
Press to skip to the next track if multiple tracks have been selected.
- * You may use the left and right directional buttons to advance or rewind in a track. Press the button again to increase how fast the track advances.
Press the Play/Pause button to resume playback.

The left and right directional keys also function as rewind and fast-forward keys when viewing multimedia files.

Basic connections

Connecting the power cord

- 1 Connect the AC cord into the AC input on the back of the set.
- 2 Connect the plug to the wall outlet as shown.

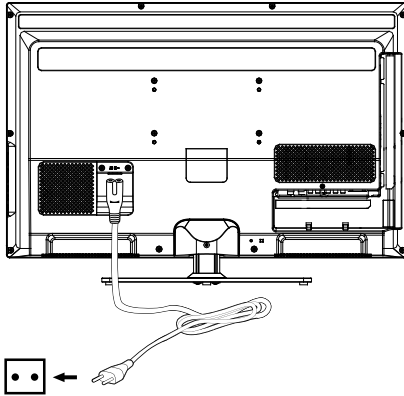

Setting up the remote control

- 1 Open the cover on the bottom of the remote unit.
- 2 Insert two AA batteries (supplied) to match the polarity indicated inside the battery compartment.

Enjoying analog and digital TV

Connecting an antenna/cable

Connect the antenna cable to the appropriate antenna terminal on the back of the TV set as shown below.

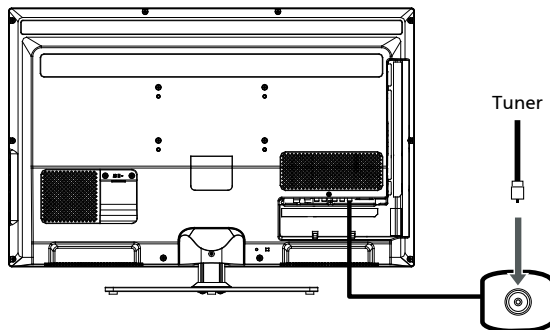

Getting started watching your TV

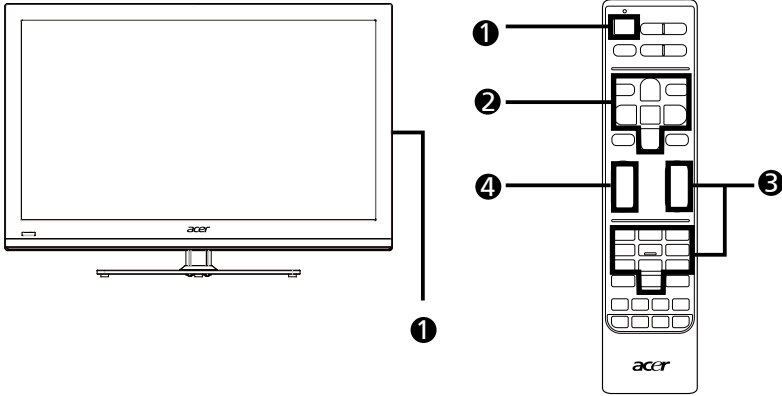

1 Power

Press the power button on the remote control or TV set.

2 Installation Guide

The first time you switch on the TV, you will be asked to select the language and scan for channels.

Press the OK key to begin the setup process.

Step 1. Select the setup language you prefer.



You can also adjust these settings using the side control panel. Please see "Front and side panels" on page 5 for details.

Step 2. Please select the correct country for signal reception.

Step 3. Select the correct tuner mode.

Step 4. Ensure that your co-axial cables are connected correctly before proceeding.

Step 5. Scan for digital channels and analog channels.

Step 6. Select Home mode.

Step 7. Setup is now complete. You are ready to begin watching TV.

3 Changing channels

a. Press 0 - 9 on the remote control to select a channel. The channel changes after 2 seconds. Press OK to select the channel immediately.

b. Pressing the channel (CH) up / down button on the remote control will also change the channel.

4 Adjusting the volume

Adjust the volume level using the (VOL) up/down button on the remote control.



Setup may vary due to local broadcast differences.

Wall mount preparation / removing the base



Caution: Disassemble the base carefully otherwise the plastic parts and/or TV body may be damaged.

- 1) Remove the base.
- 2) Remove the screws from inside the stand.

AT2618MF/AT3218MF

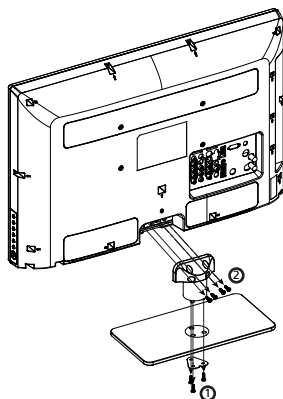

AT2628ML/AT3228ML/AT4028ML

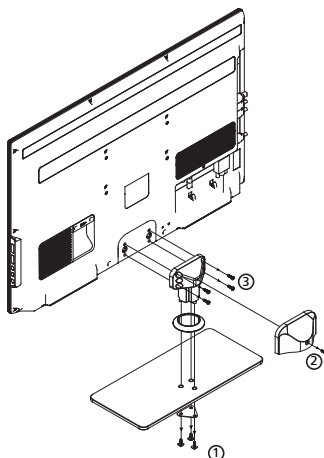

- 3) Assemble the wall mount following the instructions included with the wall mount.

Connecting external audio/video devices

Connecting a DVD, VCR, STB or audio/video equipment

Connect your DVD player, VCR or audio/video equipment using the input ports located at the rear of your LCD TV as shown below.

Source-in

for AT3228ML/AT4028ML

for AT2628ML/AT2618MF/AT3218MF

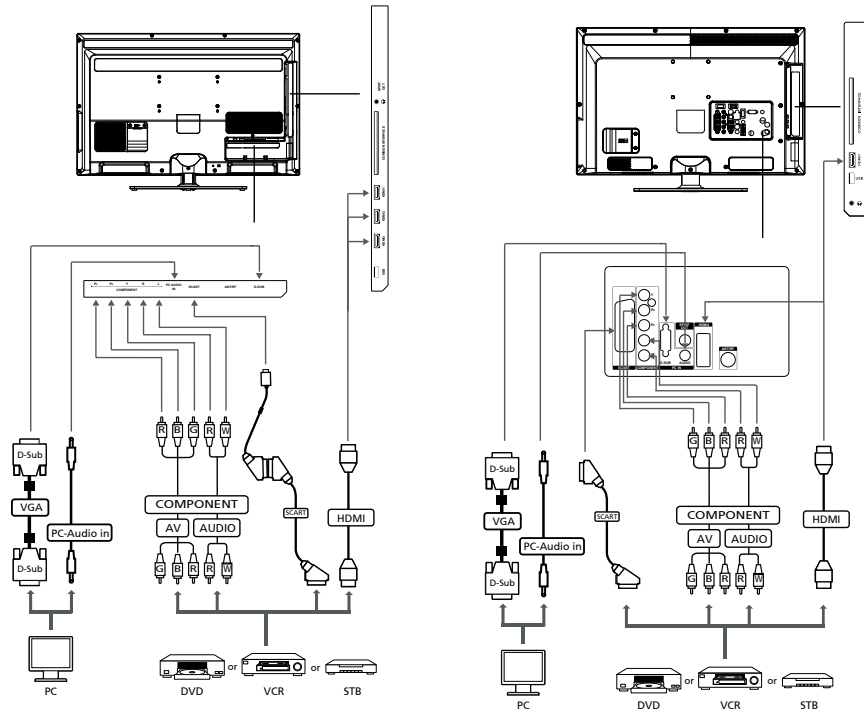

 Green
  Yellow
  Red
  White
  Blue



* Acer recommends the following priority for connection types:
HDMI -> COMPONENT -> AV (SCART).

TV-out

for AT3228ML/AT4028ML

for AT2628ML/AT2618MF/AT3218MF

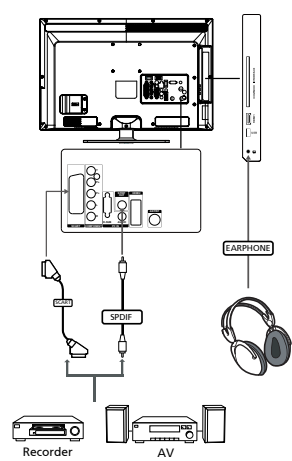
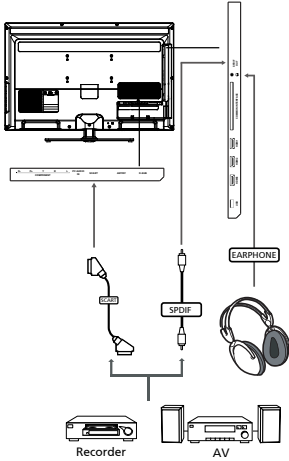

Connecting a camera, camcorder or game console

Connect your camera or camcorder to the video/audio ports on the TV set as shown below.

for AT3228ML/AT4028ML

for AT2628ML/AT2618MF/AT3218MF

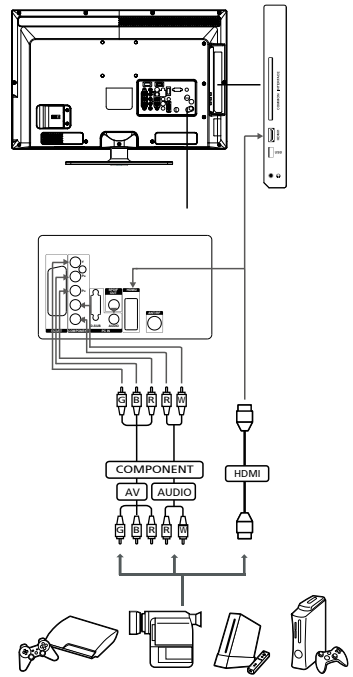
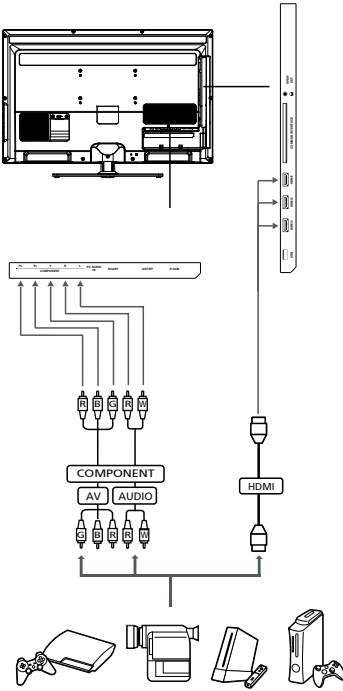

English

Connecting a PC or notebook computer

To display PC output on your TV, connect your PC or notebook computer to the TV as shown below.

for AT3228ML/AT4028ML

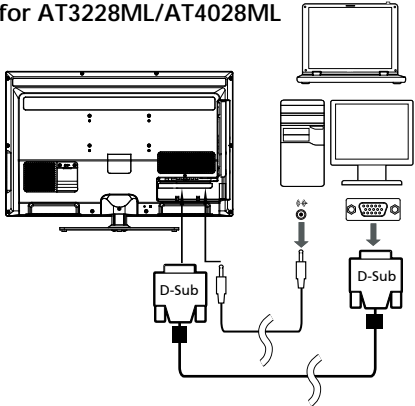

for AT2628ML/AT2618MF/
AT3218MF

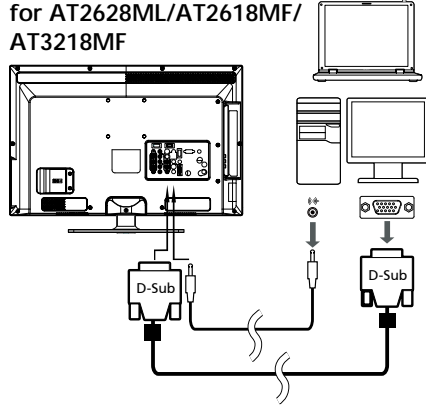

For VGA connections, Acer recommends setting your PC's external monitor resolution to 1920 x 1080 pixels @ 60 Hz refresh rate for AT3218MF/AT3228ML/AT4028ML and 1366 x 768 pixels @ 60 Hz refresh rate for AT2618MF/AT2628ML.

Connecting a USB storage device

To display multimedia content on your TV, connect the USB device to the TV as shown below.

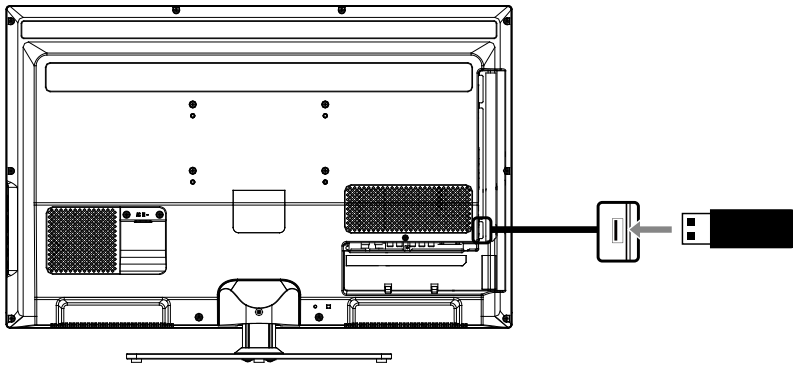

Selecting the input source

Once you have connected your antenna or external equipment to the TV, you need to select the correct input source.

Press the SOURCE button on the remote control to display the Source menu. Use the up/down directional keys to navigate the list and press OK to confirm the input you wish to watch: TV/CMP/AV/VGA/HDMI1/HDMI2/HDMI3 (HDMI3 only for AT3228ML/AT4028ML).

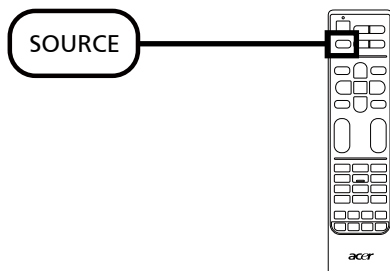

Playing multimedia files from a USB storage device

Connecting a USB storage device

Connect the USB storage device to the USB port on your TV, the TV will enter the media center menu directly.

Supported file formats:

Photo JPG, JPEG

Music MP3, AC 3, LPCM, ADPCM, AAC, MPEG

Video AVI, MPEG1, MPEG2, H.264 BP/MP/HP, MPEG4 SP/ASP



Note: Some USB keys and USB products like digital cameras or mobile phones are not fully compatible with USB 2.0 standard so it may not work with the TV multimedia player. Not all USB devices are compatible with the multimedia player.

Navigating in the multimedia screen

There are three main areas of the multimedia screen:



a. Media type bar

The top of the screen shows the type of media being viewed: Photo, Music or Video.

b. Navigation menu

The middle of the screen shows the contents of the USB device. Use the directional keys and press OK to open a file or folder. Some information of the selected file appears on the left. Press the MENU button to display the options: Sort, Edit and Parser.

Sort: sorting files or folders.

Edit: including the Copy, Paste and Delete options.

Parser: Selecting Recursive to display all the files of the selected media type.



Note: Only files that match the selected media type are displayed.

Press the **BACK** button to return to the folder that contains the folder being viewed.

c. File option bar

The bottom of the screen shows addition options for the file being viewed, such as volume level or functions for the buttons on the remote control.



Note: When playing a file, the top bar will disappear. When playing a movie or viewing photos, the bottom bar will disappear after a short delay. Press **MENU** to display it.

View Photo

Select a picture and press **OK** to open it. Picture files will be shown in a slideshow. Press **OK** or **Play/Pause** to pause the display on a specific photo.



Press the **MENU** key to display the information bar at the bottom.

Press the **MENU** key again to display the options list and use up/down to select an option and left/right to adjust.

To rotate a picture, press **OK** to pause on the picture and then press **MENU** to display the options list. Select **Rotate** and press **OK** repeatedly to rotate clockwise.

Press **BACK** to return to the folder navigation list.

Listen to Music

Select a music file and press **OK** to open it. Press **OK** or **Play/Pause** to pause a track.

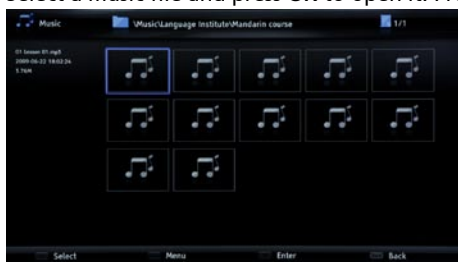

Press **Previous** ('Index') / **Next** ('Reveal') to skip to the previous track or advance to the next track in the folder.

Press the **MENU** key to display the options list and use up/down to select an option and

left/right to adjust. The menu includes the **Audio Only** option. Select it and press **OK**, you can listen to music with the screen turned off. Press any key to exit the audio only mode.

Press the left and right directional keys to advance or rewind in a track.

Press **BACK** to return to the folder navigation list and preview screen.

Watch video

Select a movie file and press **OK** to open it. Press **OK** or **Play/Pause** to pause a movie.



Press the **MENU** key to display the information bar at the bottom.

Press the **MENU** key again to display the options list and use up/down to select an option and left/right to adjust.

You may use the left and right directional keys to advance or rewind in a movie. Press the key again to increase how fast the track advances or rewinds.

Press **BACK** to return to the folder navigation list and preview screen.

Leaving multimedia storage display

Repeatedly press **BACK** to exit the USB storage.



Warning: Do not remove the USB storage device while a media file is playing. Stop playback and switch to a different source before removing the device from the USB port.



Channel controls

Channel list

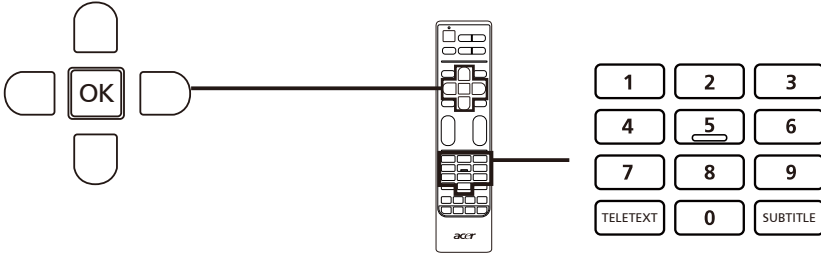
Channel list allows you to quickly find the TV channel you are searching for.

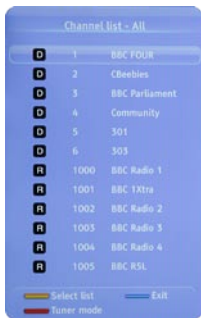

To open the channel list feature:



1		Press the OK key on the remote control. This will bring up the channel list menu.
2		The current channel will be highlighted.
3		Use the up/down directional keys to navigate the list and select the channel you wish to watch. Use the red key to switch to the tuner mode selection menu and press up/down to switch between Antenna and Cable. Use the yellow key to switch to the channel list selection menu and press up/down to switch between the All, TV, Radio and Free channel lists. Use the blue key to exit the list.

Favourite channel list

The favourite channel list allows you to store your favourite TV channels and flick between them at the touch of a button.

Viewing your favourite channels	
	On the remote control, if you press the FAV key, the TV will display a list of favourite TV channels. Use the up or down directional keys to select a channel, and then press OK.

To set a favourite channel, follow the steps described on this page.

Storing favourite channels		
1		Press the FAV key on the remote control. This will bring up the favourite channel list.
2		The Favourite list will be shown. Press OK to select, delete or add a favourite channel.
3		Press either the BACK key or FAV key on the remote control to exit.

Programme information

Press the DISPLAY key once to see information about the current programme (if available), press twice to see the lower part information and press the third time to see the channel number and the time only.

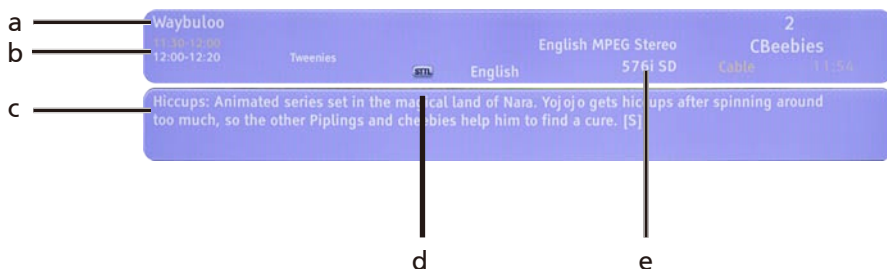

- Programme title
- Programme schedule
- Programme summary
- Subtitle
 - If 'STTL' is displayed press the SUBTITLE key to select an available subtitle.
- Audio language

Electronic programme guide

The electronic programme guide (EPG) is an onscreen service available on digital and cable TV that provides information about scheduled broadcast programmes on all digital channels by time, title and channel.

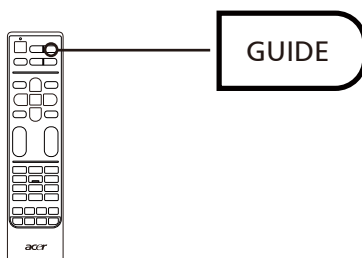

Guide screen

There are four main areas of the EPG screen:



The top of the screen shows the viewing date and the current time.



The section on the left shows all names for digital channels.

The section on the right shows information about programmes for the selected channel: the start and finish times, any age rating and a summary.

Use the up or down directional keys to switch to the previous or next channel.

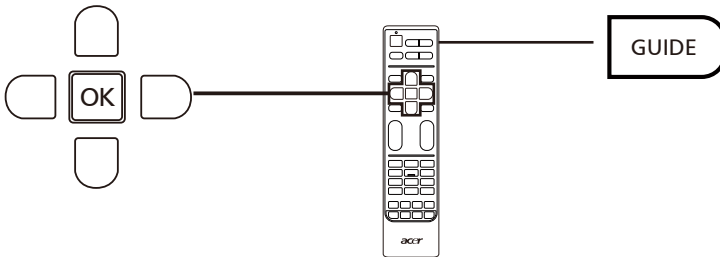
Navigating the EPG (for Digital TV mode)



1		Press the GUIDE key on the remote control.
2		Use the directional keys to navigate around the EPG menu and press OK to select your highlighted option.

OSD navigation

Many of the advanced settings and adjustments are available through using the OSD (onscreen display) menus, as shown in the example screenshot below.

Basic operations required to navigate these menus (Picture, Sound, PAP, Options, USB, Timer, Lock and Setup) are described in this section.

Navigating the OSD with the remote control

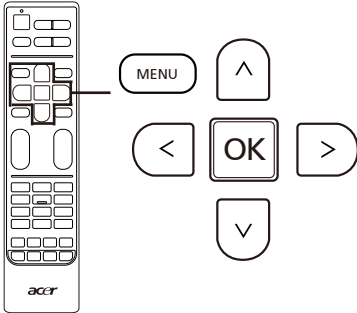

You can also interact with these menus using the right panel controls. Please see "Front and side panels" on page 5 for details.

There are eight main OSD menus. These are: Picture, Sound, PAP, Options, USB, Timer, Lock and Setup. Use the following method to navigate these menus.

1		<p>Press the MENU button on the remote control or the MENU button on the control panel.</p>
2		<p>Select your desired menu by using the up/down and left/right directional keys to switch between the eight menus.</p> <p>Press OK to enter a menu.</p> <p>Press MENU to return to the main menus.</p>
3		<p>Use the directional keys to interact with the menu. The up / down directions will scroll through the menu options, while left/right will adjust the different settings (for example, in the Picture menu, settings such as Brightness, Contrast, etc.). For some options with submenu, press OK or right to enter. Press BACK to exit.</p>

Adjusting the OSD settings

The OSD can be used for adjusting the settings of your LCD TV.

Press the MENU key to open the OSD. You can use the OSD to adjust the picture quality, audio settings, channel settings and general settings. For advanced settings, please refer to the following page:

Adjusting picture quality



- 1 Press the MENU key to bring up the OSD.
- 2 Using the directional keys, select Picture from the OSD. Then navigate to the picture element you wish to adjust.
- 3 Use the left or right keys to adjust the sliding scales or select one of the preset picture modes. Press MENU to save and exit.
- 4 The Picture menu can be used to adjust the current Picture preset, Brightness, Contrast, Saturation, Sharpness, ECO dynamic back light and other image-related qualities.

Adjusting sound settings



- 1 Press the MENU key to bring up the OSD.
- 2 Using the directional keys, select Sound from the OSD. Then navigate to the feature you wish to adjust.
- 3 Use the left or right keys to adjust the sliding scales or select one of the preset sound modes. Press MENU to save and exit.
- 4 The Sound menu can also be used to adjust the current Sound preset, Balance, Wide stereo, Audio delay and other important sound-related settings.

Adjusting PAP settings



- 1 Press the MENU key to bring up the OSD.
- 2 Using the directional keys, select PAP from the OSD.
- 3 Use the left/right directional keys to turn on PAP function.
- 4 When the PAP is turned on, you can adjust the TV position: Left or Right.

Adjusting options settings



- 1 Press the MENU key to bring up the OSD.
- 2 Using the directional keys, select Options from the OSD. Then navigate to the feature you wish to adjust.
- 3 The Options menu can be used to adjust the screen Subtitle, Decoding page language, Digital teletext language and other important settings.

Adjusting timer settings

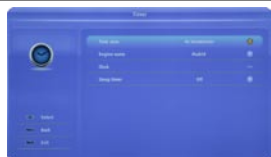

- 1 Press the MENU key to bring up the OSD.
- 2 Using the directional keys, select Timer from the OSD. Then navigate to the feature you wish to adjust.
- 3 The Timer menu can be used to select the Time zone, Clock and Sleep timer.

Adjusting lock settings

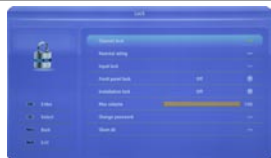

- 1 Press the MENU key to bring up the OSD.
- 2 Using the directional keys, select Lock from the OSD. Then navigate to the feature you wish to adjust.
- 3 The Lock menu can be used to adjust the Channel lock, Parental rating, Input block, Front panel lock and other important settings.

Adjusting setup settings



- 1 Press the MENU key to bring up the OSD.
- 2 Using the directional keys, select Setup from the OSD. Then navigate to the feature you wish to adjust.
- 3 The Setup menu can be used to adjust the Language, Country, Tuner mode, Channel install and other important settings.



The options available on the OSD may vary depending on the TV signal source and model. Some digital options may not be available with an analog signal and vice versa.

Picture settings

Open the Picture menu as described in the OSD navigation section. This menu provides the following settings:

Picture preset

This TV provides preset viewing modes designed to give you the best picture quality when watching a particular kind of programme. These provide preset values for brightness, contrast, hue colour and sharpness. There are pre-defined audio and video settings for optimal enjoyment of the following viewing modes: ECO, Vivid, Studio, Personal, Movie.

Mode	Information
ECO	ECO mode allows you to watch your favourite channels while reducing power requirements.
Vivid	Vivid mode allows you to watch your favourite channels with brilliant image via adaptive brightness and contrast adjustments for bright surroundings.
Studio	Studio mode allows you to watch your favourite channels with dark imagery via adaptive brightness and contrast adjustments.
Personal	Personal mode allows you to save your favourite video settings.
Movie	For comfortably enjoying movies at home, Movie mode displays dim scenes in clear detail; compensates for colour; and smoothly presents motion images. This is accomplished through optimal Gamma correction plus saturation, brightness and contrast adjustments.

Brightness

Change the brightness of the image.

Contrast

Change the contrast of the image.

Saturation

Change the colour depth of the image.

Sharpness

Change the sharpness of the image.

ECO dynamic back light

This setting adjusts the power saving mode. You can set it to Auto, High, Middle and Low depending on your preference.

Color temperature

This setting adjusts the color temperature of the image. You can set it to **Normal**, **Warm**, **Cool** depending on your preference.

Screen mode

This setting adjusts the screen mode of the image. You can set it to **Cinerama**, **14:9 Zoom**, **16:9 Zoom**, **16:9 Zoom up**, **Wide Zoom**, **Zoom 2**, **16:9 format** and **4:3 format** modes depending on your preference.

Auto format

Turn on or off auto format function.

Advanced video

This setting adjusts the video quality.

Sound settings

Open the Sound menu as described in the OSD navigation section. This menu provides the following settings:

Sound preset

This TV provides preset audio modes designed to give you the best sound quality when listening to a particular kind of programme. These provide preset values for treble and bass. There are pre-defined audio and video settings for optimal enjoyment of the following scenarios: **Rock**, **Pop**, **Live**, **Dance**, **Techno**, **Classic**, **Soft**, **Personal**. For example, **Soft** mode accentuates symphonic harmonies and the tenor audio range.

Balance

Change the balance between the left and right speakers.

Audio delay

Play it back after a period of time to create the sound of a repeating.

Wide stereo

Turn wide stereo on to add virtual surround sound.

Auto volume control

You can set it to control the volume of programme.

Sound type

Select a sound type available for the selected analog programme.

Audio language

Select an audio language available for the selected digital programme.

Type

Select to active Visually Impaired options.

Visually impaired

Set overall volume and if Visually Impaired mode uses speakers, headphones or both.

PAP function

Open the PAP menu as described in the OSD navigation section. This menu provides the following settings:

PAP

Turn the PAP function on or off. When PAP function is turned on, you can display the pictures from different source inputs side by side. Note that one window is for analogue or digital TV inputs, the other is for VGA, HDMI or CMP inputs.

Note: this PAP function is not available for AV inputs.

TV position

Select the position for TV input window, left or right.

You can toggle the focus window by pressing the left/right directional keys. When focus in TV input window, the digit keys and CH+/- keys work in TV input window. When focus in the other window, CH+/- keys can change available extension sources.

Options settings

Open the Options menu as described in the OSD navigation section. This menu provides the following settings:

Subtitle

Use these settings to adjust subtitles.

Subtitle

Turn on or off subtitles.

Digital subtitle language

Select a language as your preferred subtitle language.

Digital subtitle language 2nd

Select a language as your secondary subtitle language.

Subtitle type

You can choose between normal subtitles and subtitles for the hearing impaired, when these are available.

Decoding page language

Select the type of language used for teletext pages.

Digital Teletext language

Select the primary language used for digital teletext pages.

SPDIF type

Select a proper sound type for the current programme to output sound to the audio device connected through the SPDIF output terminal. The options you may choose depend on the programme you are watching. If the programme outputs sound in Dolby D format, you can select Dolby D or PCM. If the programme does not output sound in Dolby D format, you can select PCM only, otherwise no sound output. You can select Off to turn off the sound output.

SPDIF delay

If PCM is selected for SPDIF type, you can adjust the delay time to synchronize the sound with the image at this option.

Clear.fi link

Search for CEC (Consumer Electronics Control) devices connected to the HDMI ports on your TV. CEC allows you to control several devices with a single remote control.

Network update

Turn on or off network update function.

Common interface

Displays information about any card installed in the common interface slot. You have to switch off the TV before inserting a card. Be sure to insert the card gently and push it in as far as it will go. Wrong insertion may damage both the card and your TV.

Location

Select your location: **Home** or **Shop**.

Note: In Home mode, the TV will automatically enter Standby mode if there are no operations performed for more than four hours.

Software update

Current version

Display the current version of the software.

Product name

Display the model number.

OAD (over air download)

Enable you to install the latest version of the software if available. Press **OK** to enter the setup menu. Select **Manual OAD download** and press **OK** to start manual scanning the latest software. Press **OK/BACK** to cancel or exit the process.

Select **Auto download** and press left/right to select **Yes** to execute the automatic download or select **No** to decline the automatic download.

Timer settings

Open the Timer menu as described in the OSD navigation section. This menu provides the following settings:

Time zone

Select a time zone.

Clock

Auto synchronization

Turn on auto synchronization and the TV will detect the time from digital channels.

Date

If auto synchronization is turned off, you can set the date manually.

Time

If auto synchronization is turned off, you can set the time manually.

Power on timer

If this is on, the TV will power on at the set time and on the set channel or last source.

Power off timer

If this is on, the TV will power off at the set time.

Sleep timer

Set a time for sleep timer or turn off sleep timer.

Lock settings

Open the Lock menu as described in the OSD navigation section. Lock menu allows you to enter a password and effectively stop anyone without the password from watching TV. The default password is 1234. If you forget your code, use the super password 0423 to override any existing codes.

This menu provides the following settings:

Channel lock

Press OK or right to see the list of channels. Use the up and down directional keys to select the channel to block and then press OK to lock. Press the OK again to unblock a channel.

When viewing channels, if a blocked channel is selected the TV will ask for your password. Enter your password to view the channel.

Parental rating

Most digital TV allows you to block content according to rating systems. The rating system used is dependent on region, and is only available on digital channels. Analog channels will not be blocked with this option.

Input lock

Press **OK** to see the list of input sources (AV, HDMI, etc.). Use the up and down directional keys to select the input source to block and then press **OK** to lock. Press the **OK** again to unblock an input source.

Front panel lock

Lock or unlock the keys on the side panel.

Installation lock

Lock or unlock the setup menu.

Max volume

Set a maximum volume.

Change password

You can change the default password to a 4-digit code of your choice. If you are using the parental controls, then we recommend you change the password periodically.

Clean all

Return all parental settings to default values, removing any changes.

Set up the TV

Open the Setup menu as described in the OSD navigation section. This menu provides the following settings:

Language

Use these settings to adjust language.

Country

Select the country you live in to scan for the correct signals.

Tuner mode

Select a tuner mode: **Antenna** or **Cable**.

Channel install

Automatic search

Automatic search allows you to scan for channels. If you completed the setup wizard the first time you turned on your TV, all available channels are listed.

Wait until the scan has finished; this will take several minutes. During the scanning process, press **MENU** or **BACK** to abort halfway with all searched channels saved.

Automatic update

If the tuner mode is **Antenna**, you can use **Automatic update** to scan for new or deleted channels.

Analog manual scan

You can manually scan an analog channel by adjusting the settings here.

Digital manual scan

You can manually add a channel by adjusting the settings here.

Clean channel list

You can manually clean all channels you set here.

Organiser

You can use these settings to skip channels, change a channels' number and name or sort channels.

Input settings

Select a type of apparatus for each connector with equipment connected.

Decode

Use the up/down directional keys to select an analog channel and press OK to decode.

Diagnostics

Display signal information about the current digital channel.

Time shift

Turn the Time shift feature on or off.

Reset shop

Allow you to reset the TV to factory default settings. You have to enter a correct password to reset all settings. After resetting the initial setup menu will appear.

Special functions

Before you use the Time shift or PVR functions, connect a USB storage device to the TV.

Time shift

This allows you to record TV programs so that you won't miss your favorite moments, even if you go out. Before using the Time shift function, you must connect and set up a USB storage device.

Press the **HOLD** button on the remote control to display the time shift menu. Press the red button to enter the time shift menu, and then use the remote control to perform the functions shown on screen.

The first time you use time shifting, follow the instructions to set up your USB storage device.

Notes:

- 1) It is recommended you use a USB device with more than 1 GB unused free space and a read/write speed greater than 5.0 Mb/sec.
- 2) If you switch channel while using time shifting, a message will ask you to confirm that you want to stop time shifting.

PVR(Personal Video Record)

This allows you to record your favorite programs.

Press the **SIZE** button on the remote control to display the PVR menu; then press the red button to start recording. The recorded file can be accessed in the video section of the Media center. The file is saved in the **PVR** folder, named after the channel number.

Use the remote control to perform the functions shown on screen; use the directional keys to set the recording duration.

Notes:

- 1) This function is only available for digital channels.
- 2) This function requires a USB memory device that uses the FAT32 file format.
- 3) If you switch channels or input source, a message will ask you to confirm that you want to stop the PVR function. Select Yes to exit PVR and save all data recorded so far.
- 4) Recording duration ranges from 2 minutes to 5 hours depending on the USB storage.
- 5) The PVR function cannot be used with a CI+ card.
- 6) Due to specific country requirements, the PVR function is not available in Finland.

Troubleshooting

Before you call the Acer service center, please check the following items:

Here is a list of possible situations that may arise during the use of your LCD TV. Easy answers and solutions are provided for each.

There is no picture or sound

- Make sure the power cord is properly inserted in the power outlet.
- Make sure the input mode is correctly set by your selected input.
- Make sure the antenna at the rear of the TV is properly connected.
- Make sure the main power switch is turned on.
- Make sure the volume is not set to minimum or the sound is not set to mute.
- Make sure the headphones are not connected.
- Reception other than those of broadcasting stations can be considered.

Picture is not clear

- Make sure the antenna cable is properly connected.
- Consider whether your TV signal is being properly received.
- Poor picture quality can occur due to a VHS camera, camcorder, or other peripheral being connected at the same time. Switch off one of the other peripherals.
- The 'ghost' or double image may be caused by obstruction to the antenna due to high-rise buildings or hills. Using a highly directional antenna may improve the picture quality.
- The horizontal dotted lines shown on the pictures may be caused by electrical interference, e.g., hair dryer, nearby neon lights, etc. Turn off or remove these.

Picture is too dark, too light or tinted

- Check the colour adjustment.
- Check the brightness setting.
- Check the sharpness function.
- The fluorescent lamp may have reached the end of its service life.

Remote control does not work

- Check the batteries of the remote control.
- Make sure the remote sensor window is not under strong fluorescent lighting.
- Try to clean the remote control sensor lens on the TV with a soft cloth.
- Use the buttons (hotkeys) on the TV before the remote control works.

If the above suggestions do not solve your technical issue, please refer to the warranty card for service information.

PC input signal reference chart

AT2628ML & AT2618MF

Item	Resolution	Frequency (Hz)
1	640 x 480	60
2	640 x 480	75
3	800 x 600	60
4	800 x 600	75
5	1024 x 768	60
6	1024 x 768	75
7	1366 x 768	60

AT3228ML & AT4028ML & AT3218MF

Item	Resolution	Frequency (Hz)
1	640 x 480	60
2	640 x 480	75
3	800 x 600	60
4	800 x 600	75
5	1024 x 768	60
6	1024 x 768	75
7	1280 x 1024	60
8	1280 x 1024	75
9	1600 x 1200	60
10	1366 x 768	60
11	1920 x 1080	60



PC input does not support Sync on Green, Composite Sync or interlaced signals.

Product specifications

Model	AT2628ML	AT3228ML	AT4028ML
Panel spec			
Resolution (pixels)	1366 x 768	1920 x 1080	
Brightness (typ.)	350 cd/m ²	400 cd/m ²	
Dynamic Contrast Ratio (max.)	3000:1	4000:1	
Viewing angle (typ.)	89°(H), 89°(V)		
Response (typ.)	6.5 ms		8 ms
Power supply			
Input	220 Vac to 240 VAC, 50 Hz		
Max. power consumption	43 W	70 W	110 W
Power saving	<0.5 W	<0.3 W	
Mechanical			
Dimensions (W x H x D mm)	645.2 x 462.6 x 155	764 x 538 x 183	951.3 x 655.4 x 231
Weight (kg)	6.55	9.7	15.1
Weight (lbs.)	14.5	21.3	33.3
Gross weight (kg)	8.18	11.5	18.1
Gross weight (lbs.)	18.03	25.3	39.9
Wall-mounting holes	VESA, 100mm x 100mm	VESA, 200mm x 100mm	VESA, 400mm x 400mm
Analog TV system			
Colour system	PAL, SECAM		
Sound system	B/G/D/K//L		
Stereo system	NICAM/A2		
Subtitle	Teletext 1.5 (1000 pages)		
Digital TV system			
Digital TV standard	DVB-T HD (H.264)/DVB-C		
Sound system	PCM/ MPEG (Layer I & II), HE-AAC Dolby Digital/Dolby Digital plus		
Frequency	7/8 MHz		

Model	AT2628ML	AT3228ML	AT4028ML
Terminal			
Analog/Digital Tuner In	Hybrid		
SCART	CVBS (In), RGB (In), Audio R/L (In/Out) ATV/DTV CVBS out		
Component in	YPbPr, Audio (R/L)		
HDMI 1	Yes (HDMI 1.3)		
HDMI 2	Yes (HDMI 1.3)		
HDMI 3	No	Yes (HDMI 1.3)	
PC D-sub in	Yes		
PC audio in	Yes		
SPDIF out	Yes (Coxial)	Yes (Optical)	
Headphone out	Yes		
USB Port	Yes		
HDMI			
HDMI	480i/p, 576i/p, 720p, 1080i, 1080p		
Speakers			
Speakers	3W x 2	5W x 2	
Photo			
Photo	JPG, JPEG		
Audio			
Audio	MP3, AC3, LPCM, ADPCM, AAC, MPEG		
Video			
Video	MPEG1, MPEG2/H.264 BP/MP/HP, MPEG4 SP/ASP		

Model	AT2618MF	AT3218MF
Panel spec		
Resolution (pixels)	1366 x 768	1920 x 1080
Brightness (typ.)	450 cd/m ²	400 cd/m ²
Dynamic Contrast Ratio (max.)	4000:1	5000:1
Viewing angle (typ.)	89° (H), 89° (V)	
Response (typ.)	8 ms	6.5 ms
Power supply		
Input	220 Vac to 240 VAC, 50 Hz	
Max. power consumption	80 W	110 W
Power saving	<0.5 W	
Mechanical		
Dimensions (W x H x D mm)	656 x 483 x 165	785 x 575 x 196
Weight (kg)	6.9	9.74
Weight (lbs.)	15.18	21.43
Gross weight (kg)	8.7	12.2
Gross weight (lbs.)	19.14	26.8
Wall-mounting holes	VESA, 100 mm x 100 mm	VESA, 200 mm x 100 mm
Analog TV system		
Colour system	PAL, SECAM	
Sound system	B / G / D / K / I / L	
Stereo system	NICAM / A2	
Subtitle	Teletext 1.5 (1000 pages)	
Digital TV system		
Digital TV standard	DVB-T HD (H.264) / DVB-C	
Sound system	PCM/ MPEG (Layer I & II), HE-AAC Dolby Digital / Dolby Digital plus	
Frequency	7/8 MHz	

Model	AT2618MF	AT3218MF
Terminal		
Analog/Digital Tuner In	Hybrid	
SCART	CVBS (In), RGB (In), Audio R/L (In/Out), ATV/DTV CVBS out	
Component in	YPbPr, Audio (R/L)	
AV-in	CVBS, Audio (R/L)	
HDMI 1	Yes (HDMI 1.3)	
HDMI 2	Yes (HDMI 1.3)	
PC D-sub in	Yes	
PC audio in	Yes	
SPDIF out	Yes (Coaxial)	
Headphone out	Yes	
USB Port	Yes	
HDMI		
HDMI	480i/p, 576i/p, 720p, 1080i, 1080p	
Speakers		
Speakers	3W x 2	5W x 2
Photo		
Photo	JPG, JPEG	
Audio		
Audio	MP3, AC3, LPCM, ADPCM, AAC, MPEG	
Video		
Video	MPEG1, MPEG2, H.264 BP/MP/HP, MPEG4 SP/ASP	