

7 612 001 402

7 612 001 407

8 622 401 855 Sa 2/99

Ersatzteilliste













Mechanische Ersatzteile Front-Modul

Position	Bezeichnung	Bestell-Nr.
ME 1040	LC-Display	8 945 406 703
ME 2500	Lichtleiter / CD-Schacht	8 618 000 437
ME 3192	Befestigungswinkel (001 402)	8 618 000 426
ME 3192	Rastfeder (001 407)	8 618 000 664
ME 3207	Abdeckstreifen für CD	8 618 000 518
ME 3213	Abstandshalter für Wandlerpl.	8 638 801 430
ME 3270	Führungsschacht für CD	8 618 000 439
ME 3280	Bügel	8 618 000 480
ME 3385	Schaltmatte (links)	8 618 000 485
ME 3386	Schaltmatte (oben)	8 618 000 486
ME 3387	Schaltmatte (rechts)	8 618 000 484
ME 3400	Gerätekappe kompl.,gelasert	8 618 000 540
ME 3415	Drehknopf (2x)	8 618 000 494
ME 3461	Frontrahmen mit Haltefedern	8 618 000 415

Position	Bezeichnung	Bestell-Nr.
ME 3492	Abdeckrahmen	8 618 000 928
ME 3526	Halter für Encoderplatte (links)	8 618 000 527
ME 3527	Halter für Encoderplatte (rechts)	8 618 000 538
ME 3741	Schalterplatte	8 638 300 554
ME 3770	Wandlerplatte	8 638 300 556
ME 3780	Encoderplatte kompl. (r.6 pol.)	8 638 300 549
ME 3790	Encoderplatte kompl. (l.4 pol.)	8 638 300 550
ME 3824	Stiftleiste (20 pol.)	8 618 000 698
ME 3845	Folienleiterbahn (Display)	8 618 000 553
X 6100	Buchsenleiste (20 pol.)	8 638 801 304
X 6101	Buchsenleiste (20 pol.)	8 638 801 304

Elektrische Ersatzteile Front-Modul

Position	Bezeichnung	Bestell-Nr.
	Wandlerplatte	8 638 300 556
		
D 6100	MC 68 HC 705B	8 612 204 575
D 6310	TL 5001 CDR	8 925 901 917
D 6350	TLC 393 ID	8 925 900 607
D 6400	UC 2843 BD1	8 925 901 915
		
L 6100		8 958 411 175
L 6300		8 958 411 154
L 6320		8 958 411 154
L 6321		8 958 411 154
L 6430		8 958 411 175
L 6431		8 958 411 175
L 6440		8 958 411 175
L 6441		8 958 411 175
		
R 6114	NTC	8 951 300 005
		
T 6340		8 958 411 207
T 6400		8 958 411 203
		
V 6000	MTD 20P06	8 925 705 296
V 6001	DTC 144 WKA	8 925 705 284
V 6002	BZX 84/C18	8 925 421 059
V 6030	BC 848 B	8 925 705 043
V 6100	DTC 144 WKA	8 925 705 284
V 6120	BAS 40	8 925 405 074
V 6130	BC 848 B	8 925 705 043
V 6131	BAV 70	8 925 405 122
V 6140	DTC 144 WKA	8 925 705 284
V 6160	BC 848 B	8 925 705 043
V 6170	BC 807-25	8 925 705 178
V 6171	DTC 363 EK	8 925 705 138



Position	Bezeichnung	Bestell-Nr.
V 6310	BC 807-25	8 925 705 178
V 6311	BC 817-25	8 925 705 127
V 6312	BC 807-25	8 925 705 178
V 6320	MTD 20P06	8 925 705 296
V 6321	MBRS 340 T3	8 925 405 311
V 6330	BC 807-25	8 925 705 178
V 6340	SD 2403 GZ	8 925 705 297
V 6341	SD 2403 GZ	8 925 705 297
V 6342	BAV 99	8 925 405 124
V 6400	D1 FS4	8 925 405 014
V 6410	MTD 3055VT4	8 925 705 230
V 6420	BAV 99	8 925 405 124
V 6430	BC 807-25	8 925 705 178
V 6440	D1 FS4	8 925 405 014
V 6441	D1 FS4	8 925 405 014
		
Z 6100		8 926 193 002
	Schalterplatte	8 638 300 554
		
H 1000 -		8 925 406 033
H 1068	LMY 670	8 925 406 034
		8 925 406 035
		8 925 406 036
		
L 1001 -		8 958 411 016
L 1004		
		
V 1090	SFH 3400-2	8 925 706 706
V 1092	TFMM 5380	8 925 901 975
V 1094	DTC 363 EK	8 925 705 138
V 1096	BC 807-25	8 925 705 178



Mechanische Ersatzteile Prozessor-Modul







Position	Bezeichnung	Bestell-Nr.
ME 2020	Sicherung 10A	8 943 999 001
ME 3142	Deckel (unten)	8 618 000 618
ME 3144	Deckel (oben)	8 618 000 421
ME 3531	Antennenbuchse	8 635 123 100
ME 3620	Tuner I	8 638 203 372
ME 3640	Tuner II	8 638 308 382
ME 3633	Modul-Platte (Audio)	8 638 300 547
ME 3650	Modul-Platte (D2B)	8 638 300 548
ME 3700	Power-Platte	8 638 203 120









Position	Bezeichnung	Bestell-Nr.
ME 3720	Anschlußplatte	8 638 300 583
ME 3813	Steckerverdrahtung (6 pol.)	8 618 000 694
ME 3814	Steckerverdrahtung (10 pol.)	8 618 000 695
ME 3895	Steckerverdrahtung (20 pol.)	8 618 000 626
ME 3896	Steckerverdrahtung (12 pol.)	8 618 000 625
ME 4501	Lüfter	8 618 841 850
X 6100	Stiftleiste (20 pol.)	8 638 801 305
X 6101	Stiftleiste (20 pol.)	8 638 801 305









Elektrische Ersatzteile Prozessor-Modul









Position	Bezeichnung	Bestell-Nr.
Hauptplatte / Prozessorplatte		(8 638 300 553)
-II-		
C 1600	8200 µF	8 943 490 371
		
D 800	MC 68HC05C4	8 612 204 293
D 850	MCM	8 638 349 137
D 866	MAX 809 LEUR	8 925 904 196
D 875	LM 50 CIM 3	8 925 901 859
D 880	TJA 1053 T	8 925 904 110
D 890	TJA 1053 T	8 925 904 110
D 900	AS 82527	8 925 901 871
D 1450	MC 33078	8 925 900 225
D 1600	TDA 7454	8 945 903 750
D 1700	74 HC14D	8 925 900 189
D 1770	HA 118104 FP	8 925 901 091
D 1780	ADG 774 BR	8 925 904 597
D 1810	74 HC 4066 D	8 925 900 192
D 1820	BSP 452	8 925 705 301
D 1830	TS 7S00F	8 925 904 408
D 1850	TLV 272 IDR	8 925 900 249
D 2160	L 4938	8 925 904 376
D 2180	TLE 4276 GV	8 925 904 260
D 8100	PCF 8583 T	8 925 901 072
D 8200	L 9637 D	8 925 904 219
~		
L 1		8 958 411 010
L 4		8 958 411 112
L 20		8 958 411 102
L 22		8 958 411 102
L 23		8 958 411 102
L 600		8 958 411 106
L 752		8 948 420 016
L 753		8 948 420 016
L 790		8 948 420 016
L 791		8 950 200 000
L 792		8 958 411 112
L 793		8 958 411 112

Position	Bezeichnung	Bestell-Nr.
L 794		8 958 411 112
L 870		8 958 411 016
L 890		8 958 411 003
L 1600		8 948 411 065
L 2150		8 958 411 001
L 6000		8 958 411 002
L 6001 -		
L 6003		8 958 411 018
L 6004		8 958 411 018
L 7900		8 958 411 003
L 7910		8 958 411 016
L 7911		8 958 411 016
L 7920 -		
L 7927		8 958 411 016
L 7990 -		
L 7997		8 958 411 010
		
V 604	Z 47	8 925 421 048
V 711	BZX 84C10	8 925 421 173
V 712	BAS 21	8 925 405 182
V 766	BAS 40-05	8 925 405 024
V 767	BAS 40-05	8 925 405 024
V 768	BAS 40-05	8 925 405 024
V 801	BAL 99	8 925 405 137
V 804	DTC 144 EK	8 925 705 264
V 805	DTC 144 EK	8 925 705 264
V 866	BAW 56	8 925 405 015
V 868	BAS 40-05	8 925 405 024
V 870	BAV 99	8 925 405 124
V 875	BC 848 B	8 925 705 043
V 886	BC 807-25	8 925 705 178
V 887	DTC 144 VKA	8 925 705 198
V 1601	BAW 56	8 925 405 015
V 1602	BAS 21	8 925 405 182
V 1700	BSS 138	8 925 705 132
V 1701	BC 858 C	8 925 705 039
V 1810	DTC 144 WKA	8 925 705 284
V 1820	BC 858 C	8 925 705 039
V 1821	BAS 21	8 925 405 182
V 1830	BAS 21	8 925 405 182
V 1831	BAL 99	8 925 405 137

Position	Bezeichnung	Bestell-Nr.
V 1832	BC 848 B	8 925 705 043
V 1833	BZX 84/C5V6	8 925 421 037
V 1834	BAV 99	8 925 405 124
V 1850	BAV 99	8 925 405 124
V 1851	BZX 84/C5V6	8 925 421 037
V 1852	DTC 143 ZK	8 925 705 234
V 1856	BC 848 B	8 925 705 043
V 1860	BAS 21	8 925 405 182
V 1861	BC 858 C	8 925 705 039
V 1862	BC 848 B	8 925 705 043
V 1863	DTC 124 EK	8 925 705 263
V 1864	BAL 99	8 925 405 137
V 2001	S 3 G	8 925 405 023
V 2060	DTC 144 WKA	8 925 705 284
V 2061	MTD 20P06HD	8 925 705 296
V 2062	BZX 84C18	8 925 421 059
V 2063	MTD 20P06HD	8 925 705 296
V 2064	DTC 144 WKA	8 925 705 284
V 2065	BAV 70	8 925 405 122
V 2066	BC 858 C	8 925 705 039
V 2105	BC 807-25	8 925 705 178
V 2107	BAS 21	8 925 405 182
V 2109	BAV 70	8 925 405 122
V 2110	DTC 124 EK	8 925 705 263
V 2141	BAV 70	8 925 405 122
V 2150	BC 807-25	8 925 705 178
V 2151	BC 807-25	8 925 705 178
V 2163	DTC 124 EK	8 925 705 263
V 2200	BC 848 C	8 925 705 037
V 8200 -		
V 8202	DTC 124 EK	8 925 705 263
		
Z 800		8 926 193 035
Z 864		8 926 193 034
Z 900		8 926 193 056
Z 7991		8 958 411 012
Z 8100		8 926 193 059
	Tuner I	8 638 203 372
		
D 1	U 4056	8 925 901 880
D 152	TDA 1597 T	8 925 901 450
D 180	TL 072	8 925 900 201
D 600	TDA 4362	8 925 904 388
D 650	HA 12181 FP	8 925 904 552
D 700	SDA 4330-2	8 925 901 029
		
L 1		8 958 411 133
L 2		8 928 411 072
L 4		8 948 419 068
L 5		8 948 419 067
L 6		8 948 419 066
L 605		8 958 411 208
L 608		8 958 411 181
L 610		8 958 411 181
L 630		8 948 419 049
L 700		8 928 411 060
L 2903		8 948 420 016
		
R 166		8 941 500 076
		
V 1	S 392 D	8 925 405 239
V 2	BA 980	8 925 405 238
V 3	BFR 93 AR	8 925 705 294

Position	Bezeichnung	Bestell-Nr.
V 4	BB 804	8 925 405 133
V 5	BB 804	8 925 405 133
V 6	BB 804	8 925 405 133
V 25	BC 858 C	8 925 705 039
V 101	BF 550	8 925 706 143
V 159	1N 4148	8 925 405 233
V 181	BAV 99	8 925 405 124
V 600	ON 4288	8 925 705 115
V 601	1 SV 172	8 925 405 318
V 604	BC 849 C	8 925 705 035
V 613	BC 849 C	8 925 705 035
V 614	BAV99	8 925 405 124
V 623	BC 858 C	8 925 705 039
V 630	BB 814-2	8 925 405 146
V 632	BC 848 C	8 925 705 037
V 642	BC 848 C	8 925 705 037
V 661	BC 848 C	8 925 705 037
V 741	BC 848 C	8 925 705 037
V 2900	BC 807-25	8 925 705 178
V 2905	BF 550	8 925 706 143
		
Z 1		8 948 417 028
Z 2		8 926 193 216
Z 100		8 926 193 212
Z 101		8 926 193 212
Z 102		8 926 193 212
Z 152		8 948 417 027
Z 600		8 948 417 036
Z 601		8 946 193 915
Z 638		8 948 413 016
Z 639		8 946 193 905
	Tuner II	8 638 308 382
		
D 5030	TUA 1574	8 925 900 609
D 5100	TUA 1574	8 925 900 609
D 5200	TDA 1597 T	8 925 901 450
D 5300	TL 072 IDR	8 925 900 201
D 5700	U 4280 BM	8 925 901 726
		
L 5010		8 928 411 067
L 5020		8 948 419 031
L 5027		8 958 411 000
L 5030		8 948 419 038
L 5055		8 928 411 061
L 5100		8 948 418 009
L 5114		8 958 411 006
L 5115		8 958 411 006
L 5200		8 948 417 029
L 5300		8 928 411 062
L 5700		8 928 411 060
		
V 5010	BC 858 C	8 925 705 039
V 5011	1 SV128	8 925 405 530
V 5020	BB 814	8 925 405 146
V 5021	BF 999	8 925 705 280
V 5030	BB 814	8 925 405 146
V 5040	BB 814	8 925 405 146
V 5301	BAV 99	8 925 405 124
V 5700	BAV 99	8 925 405 124
V 5701	BC 858 C	8 925 705 039
V 5703	BC 848 C	8 925 705 037
		
Z 5040		8 948 419 041

Position	Bezeichnung	Bestell-Nr.
Z 5050		8 948 418 010
Z 5100		8 926 193 031
Z 5101		8 926 193 204
Z 5102		8 926 193 204
Z 5103		8 926 193 204
	Power-Platte	8 638 203 120
		
L 2001		8 948 411 065
L 2010		8 958 411 184
L 2011		8 958 411 173
L 2020		8 958 411 185
L 2021		8 958 411 162
L 2022		8 958 411 175
	  	
V 2001	MBRS 340	8 925 405 311
V 2010	LM 2670 S-AD	8 925 904 436
V 2011	MBRS 340	8 925 405 311
V 2012	74 HC 132D	8 925 900 136
V 2030	L 4938 ED	8 925 904 376
V 2031	BZX 84C18	8 925 421 059
V 2032	DTC 143 ZKA	8 925 705 234
V 2034	DTC 144 WKA	8 925 705 284
V 2035	BAV 70	8 925 405 122
V 2036	D1FS4	8 925 405 014
		
Z 2001		8 948 411 703
	Modul-Platte (Audio)	8 638 300 547
		
D 300	TDA 7338 D	8 925 901 758
D 2400	TMS 375 C006 AY	8 925 901 581
D 2410	TDA 7332 D	8 925 900 477
D 2430	TMS 375 C006 AY	8 925 901 581
D 2440	TDA 7332 D	8 925 900 477
		
L 319		8 958 411 102
L 2406		8 958 411 001
		
V 308	BAS 40-05	8 925 405 024
V 311	DTC 114 EK	8 925 705 262
V 312	BC 848 C	8 925 705 037
V 313	DTC 144 EK	8 925 705 264
V 320	DTC 114 EK	8 925 705 262
V 321	DTC 114 EK	8 925 705 262
V 322	BAS 40-05	8 925 405 024
V 328	BC 848 C	8 925 705 037
V 330	DTA 124 EKA	8 925 705 261
V 332	BC 848 C	8 925 705 037
V 340	DTA 124 EKA	8 925 705 261
V 341	BC 848 C	8 925 705 037
		
Z 300		8 926 193 073
Z 2400		8 926 193 075





Position	Bezeichnung	Bestell-Nr.
	Modul-Platte (Video)	
		
D 1700	HD 6477034 F	8 612 204 364
D 1715	TC 7W74FU	8 925 904 290
D 1720	HG 62 G 027S4	8 925 901 827
D 1740	HYB 5118160	8 925 901 674
D 1750	TB 28F800	8 612 204 580
D 1780	HG 51 D562CP	8 925 904 051
D 2800	UPD 17107	8 925 904 201
		
L 1701		8 958 411 016
L 1702		8 958 411 016
L 1780		8 948 420 016
		
V 1700	DTC 144 EK	8 925 705 264
V 1701	DTC 114 EK	8 925 705 262
V 1702	BC 807-25	8 925 705 178
V 1703	BC 848 C	8 925 705 037
V 1704	BC 847 C	8 925 705 034
		
Z 1700		8 926 193 037
	Modul-Platte (D2B)	8 638 300 548
		
D 1400	CS 4227 BQ	8 925 904 310
D 1430	LM 837	8 925 900 205
D 1450	LM 837	8 925 900 205
D 1460	MC 33078	8 925 900 225
D 1500	D 77611	8 925 901 900
D 1900	OCC 8001	8 925 901 858
D 1901	74 HCT 125D	8 925 900 431
		
L 1400		8 958 411 001
L 1401		8 958 411 001
L 1414		8 958 411 001
L 1450		8 958 411 017
L 1451		8 958 411 017
L 1452		8 958 411 017
L 1465		8 958 411 017
L 1501		8 958 411 001
L 1502		8 958 411 174
L 1900		8 958 411 102
L 1901		8 958 411 001
L 1950		8 958 411 001
		
V 1501	DTC 114 EK	8 925 705 262
V 1502	BAL 99	8 925 405 137
		
Z 1900		8 926 193 026
	Anschlußplatte	8 638 300 583
	(nur kompl.)	





Mechanische Ersatzteile NAV-Modul

Position	Bezeichnung	Bestell-Nr.
ME 3014	NAV-Modul (D1)	8 618 842 555
ME 1301	CD-Laufwerk	8 638 812 039
ME 3140	Deckel (2x)	8 618 000 621
ME 3220	Massefeder (3x)	8 618 842 292
ME 3221	Massefeder für (GPS-Antenne)	8 618 842 293
ME 3260	Einstellring für Gyro (gelb / 25°) (7612 001 402)	8 618 842 443
ME 3260	Einstellring für Gyro (grün / 20°) (7612 001 407)	8 618 842 442

Position	Bezeichnung	Bestell-Nr.
ME 3535	Halterahmen für GPS-Modul	8 618 842 286
ME 3680	Prozessorplatte	8 638 300 360
ME 3847	Folienleiterbahn (10 pol.)	8 638 812 075
ME 3890	Buchse mit Kabel (GPS)	8 618 000 616
ME 4500	Lüfter	8 618 841 131
ME 4601	Gyro	8 618 842 457
ME 4800	GPS-Modul	8 638 348 887

Elektrische Ersatzteile NAV-Modul

Position	Bezeichnung	Bestell-Nr.
	Hauptplatte	(8 638 300 546)
		
D 1450	MC 33079 D	8 925 900 205
D 2000	LM 2596	8 925 904 024
D 5930	MC 74 HC 132D	8 925 900 136
D 5931	74 HC 14D	8 925 900 189
D 5932	MM 74 HC 123A	8 925 901 829
D 5933	TC 7S04FU	8 925 901 836
D 6630	TJA 1053 TN1	8 925 901 110
D 6631	74 HC 14D	8 925 900 189
D 6640	74 HC 4066 D	8 925 900 192
		
L 1450		8 948 420 016
L 2000		8 958 411 171
L 7900		8 958 411 154
L 7901		8 958 411 016
L 7902		8 958 411 173
L 7906		8 958 411 173
		
V 1450	BAS 40-6	8 925 405 066
V 2007	MBRS 340T3	8 925 405 311
V 2021	BC 846 B	8 925 705 229
V 5930	BAV 70	8 925 405 122
V 5962	BAV 70	8 925 405 122
V 6507	BC 846 B	8 925 705 229
V 6630	BC 858 C	8 925 705 039
V 6631	BC 846 B	8 925 705 229
V 6633	BC 817-40	8 925 705 177
V 6933	BAV 99	8 925 405 124

Position	Bezeichnung	Bestell-Nr.
	Prozessorplatte	8 638 300 360
		
D 2270	MSM 9842 GS	8 925 904 218
D 2271	SN 74 AHCT 24	8 925 904 214
D 5000	UPC 2574 B	8 925 904 261
D 5001	BA 5970 FP	8 925 904 240
D 5002	BA 6853 FS	8 925 904 309
D 5050	UPD 63724 GM	8 925 904 123
D 5051	UPD 424260	8 925 904 124
D 5052	UPD 784035	8 925 904 537
D 5053	ST 24 C01	8 609 503 000
D 5054	LM 50 CIM 3X	8 925 901 859
D 5700	UPD 4218165	8 925 904 211
D 5702	UPD 4218165	8 925 904 211
D 5703	TLV 1544 ID	8 925 904 215
D 5704	UPD 4218165	8 925 904 211
D 5705	74 VHC 00MTC	8 925 904 434
D 5706	UPD 4218165	8 925 904 211
D 5707	74 VHC 00MTC	8 925 904 434
D 5708	UPD 696633	8 925 904 161
D 5709	UPD 65848	8 925 904 154
D 5710	MAX 706 TESA	8 925 904 212
D 5711	MAX 811 LEUS	8 925 904 397
D 5712	74 ALVC 1642	8 925 904 213
D 5713	SN 74 AHC 1G	8 925 904 340
D 5714	SN 74 AHC 1G0	8 925 904 456
D 5800	AM 29 DL 800T	8 925 904 553
D 5801	AM 29 DL 800T	8 925 904 554
D 5830	AM 29 LV 160B	8 925 904 216
		
V 5000	BC 808-25	8 925 705 042
V 5051	BAS 40-04	8 925 405 065
		
Z 2273		8 926 193 047
Z 5000		8 926 193 021
Z 5700		8 926 193 069

Position	Bestell-Nr.
LW 2	8 619 000 542
LW 3	8 619 000 543
LW 4	8 619 000 549
LW 5	8 619 000 550
LW 6	8 619 000 551
LW 7	8 619 000 552
LW 8	8 619 000 553
LW 9	8 619 000 554
LW 10	8 619 000 555
LW 11	8 619 000 556
LW 12	8 619 000 557
LW 13	8 619 000 558
LW 14	8 619 000 559
LW 15	8 619 000 560
LW 16	8 619 000 561
LW 17	8 619 000 562
LW 18	8 619 000 563
LW 19	8 619 000 564
LW 22	8 619 000 565
LW 23	8 619 000 566
LW 29	8 619 000 240
LW 32	8 619 000 568
LW 33	8 619 000 569
LW 34	8 619 000 570
LW 35	8 619 000 571
LW 36	8 619 000 572
LW 37	8 619 000 573
LW 38	8 619 000 574
LW 39	8 619 000 575
LW 40	8 619 000 576
LW 42	8 619 000 577
LW 43	8 619 000 578
LW 46	8 619 000 579
LW 47	8 619 000 580
LW 48	8 619 000 581
LW 49	8 619 000 654
LW 50	8 619 000 583
LW 51	8 619 000 584
LW 54	8 619 000 585
LW 56	8 619 000 586
LW 57	8 619 000 587
LW 70	8 619 000 589
LW 71	8 619 000 590
LW 78	8 619 000 593
LW 79	8 619 000 594
LW 80	8 619 000 595
LW 81	8 619 000 596
LW 82	8 619 000 597
LW 83	8 619 000 598
LW 84	8 619 000 599
LW 85	8 619 000 600
LW 86	8 619 000 601
LW 87	8 619 000 645
LW 88	8 619 000 603
LW 89	8 619 000 604
LW 91	8 619 000 606
LW 92	8 619 000 607
LW 100	8 619 000 608
LW 101	8 619 000 609
LW 102	8 619 000 610
LW 103	8 619 000 260
LW 104	8 619 000 611
LW 105	8 619 000 612
LW 106	8 619 000 613
LW 107	8 619 000 614
LW 108	8 623 400 215

Position	Bestell-Nr.
LW 113	8 619 000 615
LW 114	8 619 000 616
LW 115	8 619 000 617
LW 116	8 619 000 618
LW 131	8 619 000 619
LW 132	8 619 000 620

Explosionszeichnung / Exploded View / Vue éclatée / Dibujo de tipo explosión
TN-CCD 1001 / BP 1 8 638 812 039

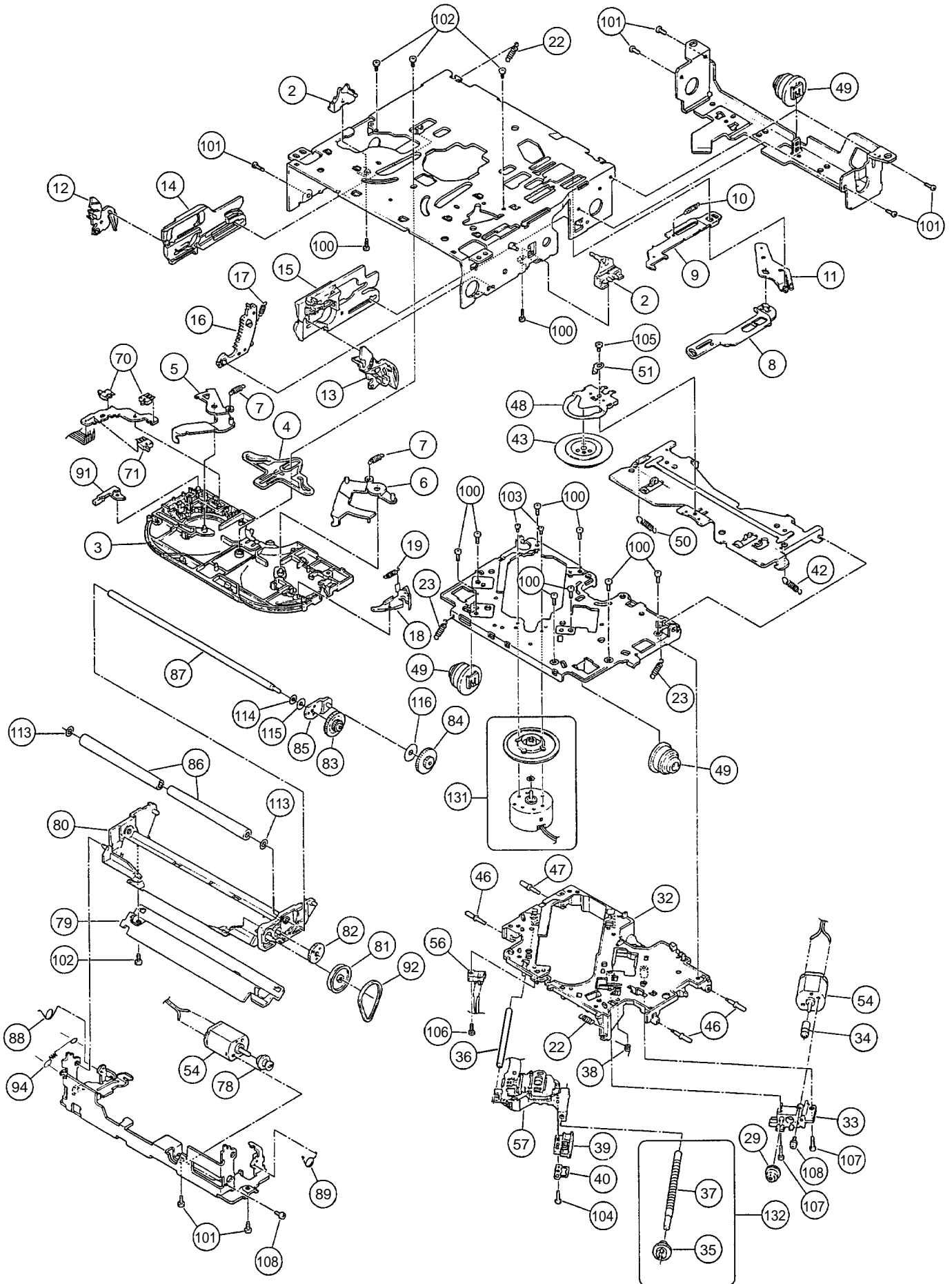

Blaupunkt-Werke GmbH, Hildesheim

Änderungen vorbehalten! Nachdruck - auch auszugsweise -
nur mit Quellenangabe gestattet!
Modification réservées! Reproduction - aussi en abrégé -
permise seulement avec indication des sources utilisées

Modification reserved! Reproduction - also by extract -
only permitted with indication of sources used
¡Modificaciones reservadas! Reproducción - también en parte
solamente permitida con indicación de las fuentes utilizadas