

FE1-100

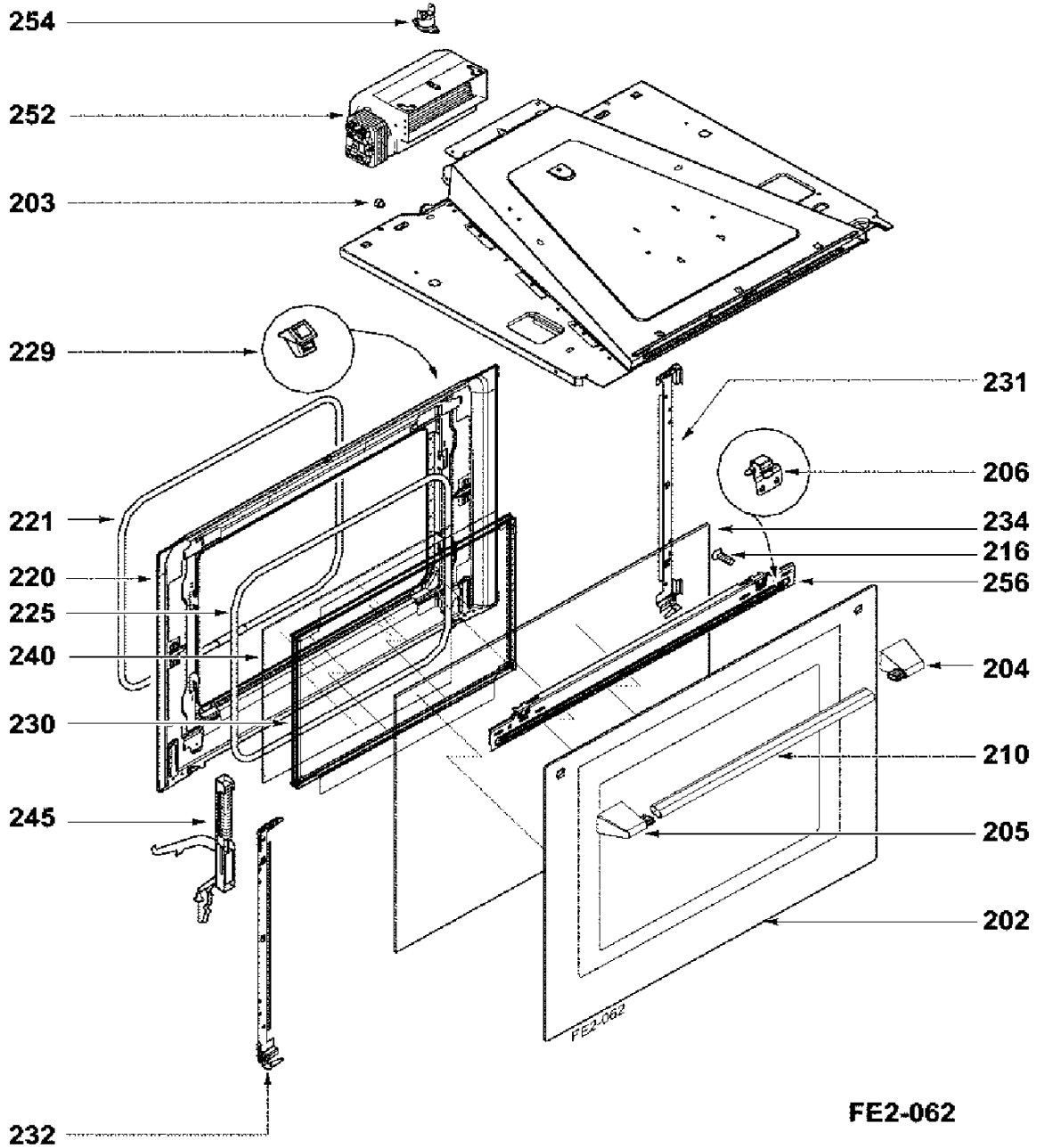

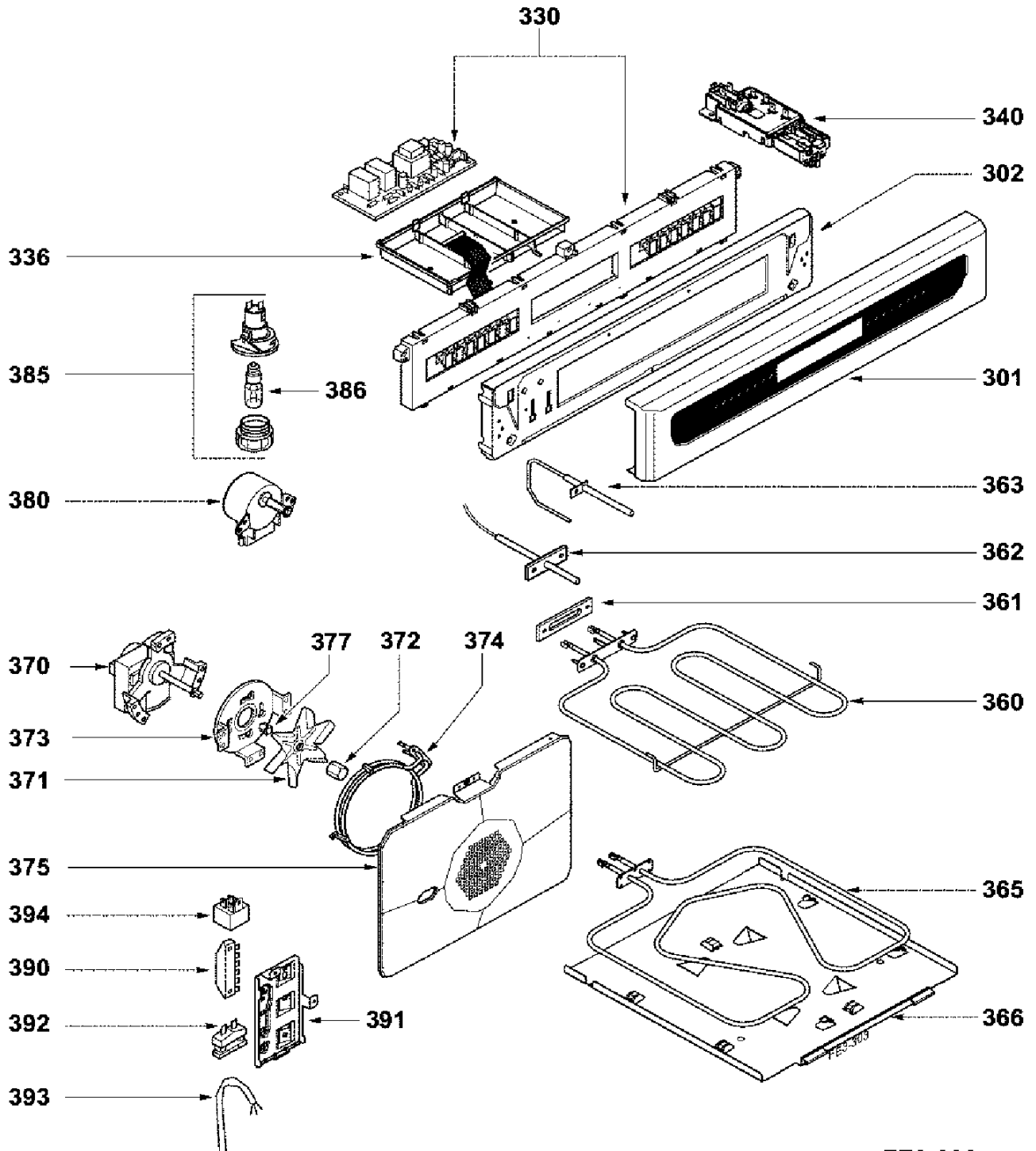

FE3-303