

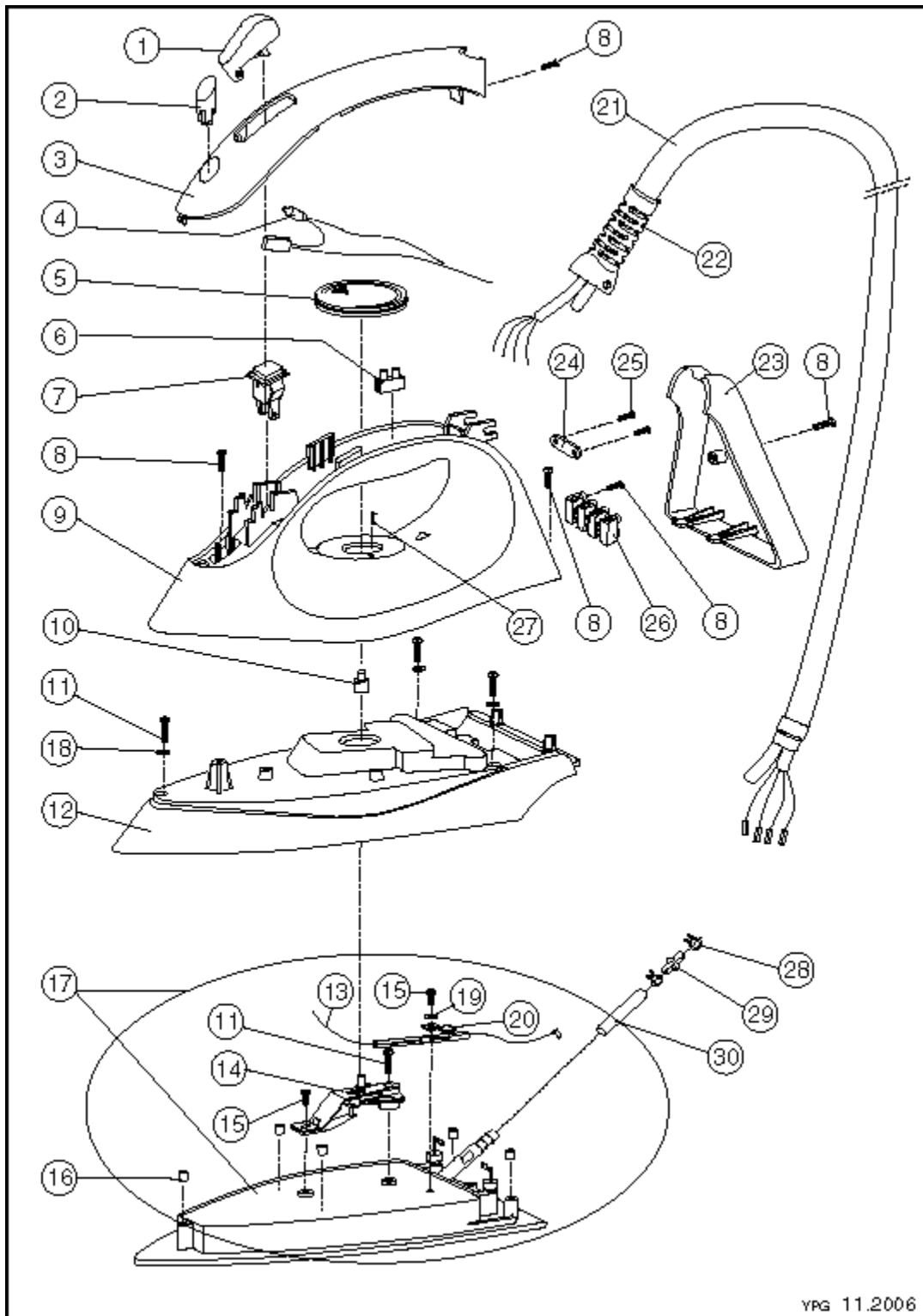







**FER XS-2 - ENSEMBLE FER A REPASSER** 



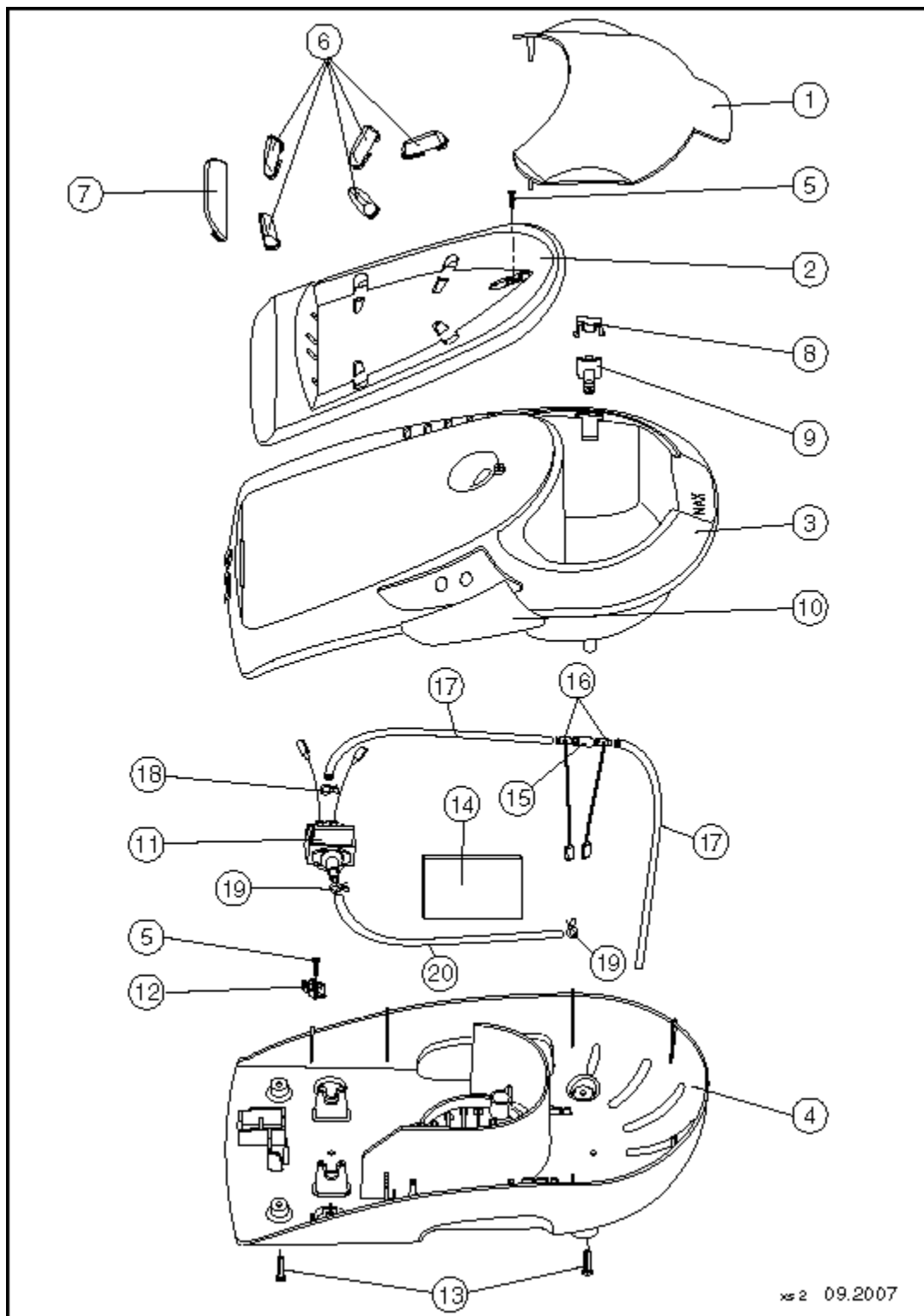



REP	QTE	No ARTICLE	DESIGNATION	
000	1	500476165	ENSEMBLE FER A REPASSER	
001	1	500473139	GACHETTE	
002	1	500473103	CAPUCHON DU VOYANT	
003	1	500473132	POIGNEE	

FER XS-2 - ENSEMBLE BOITIERS 

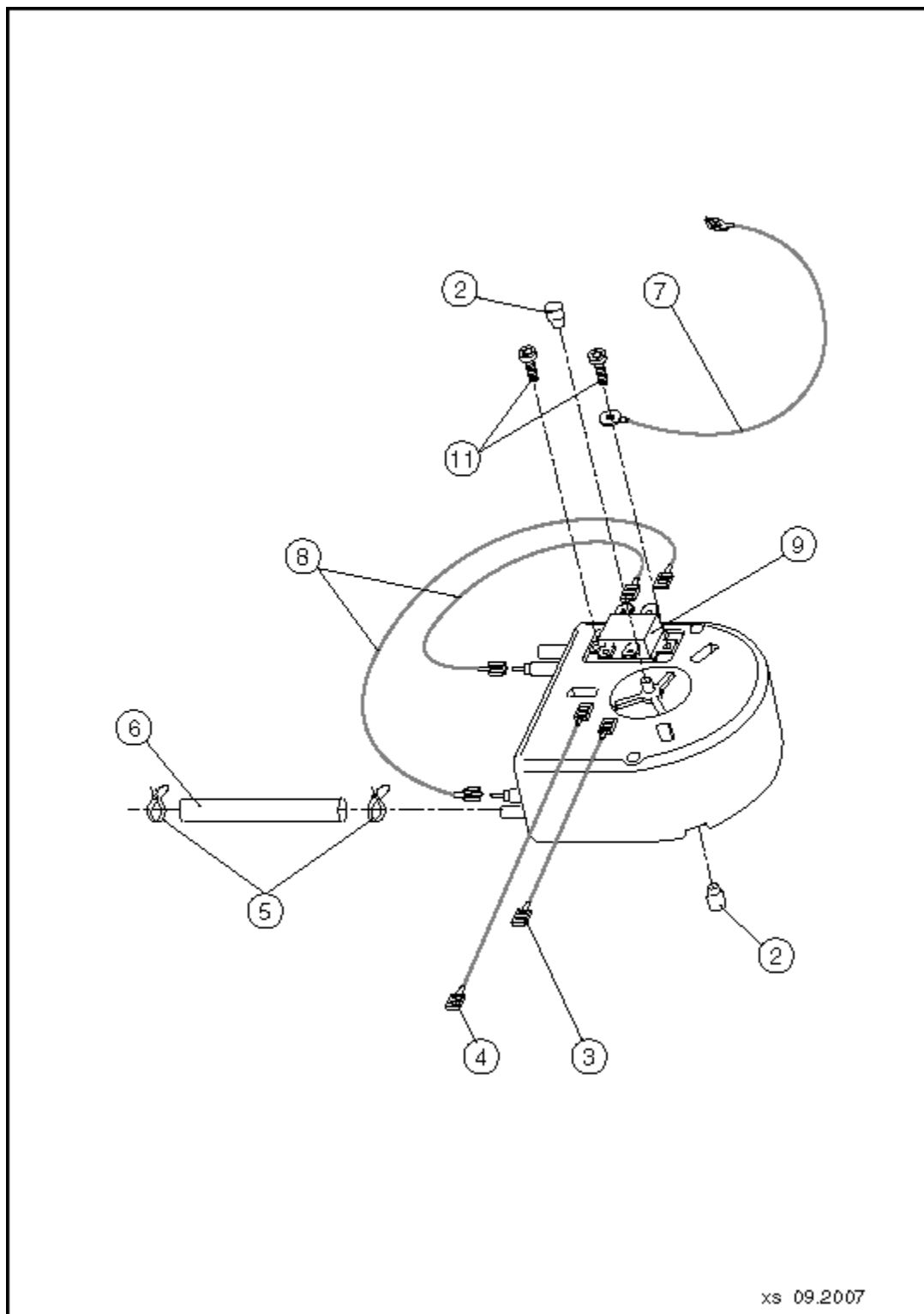
REP	QTE	No ARTICLE	DESIGNATION	
001	1	500476172	COUVERCLE BOITIER SUPERIEUR	
002	1	500476174	PLAQUE REPOSE FER	
003	1	500476177	BOITIER SUPERIEUR	
004	1	500476168	BOITIER INFERIEUR	

## FER XS-2 - ENSEMBLE GENERATEUR EXPRESS



REP	QTE	No ARTICLE	DESIGNATION	
000	1	500472201	GENERATEUR NU EXPRESS 1400W	
002	4	500411548	ENTRETOISE	
003	1	500550087	CABLE BLEU 300	
004	1	500411870	CABLE ROUGE 270	

## FER XS-2 - ACCESSOIRES

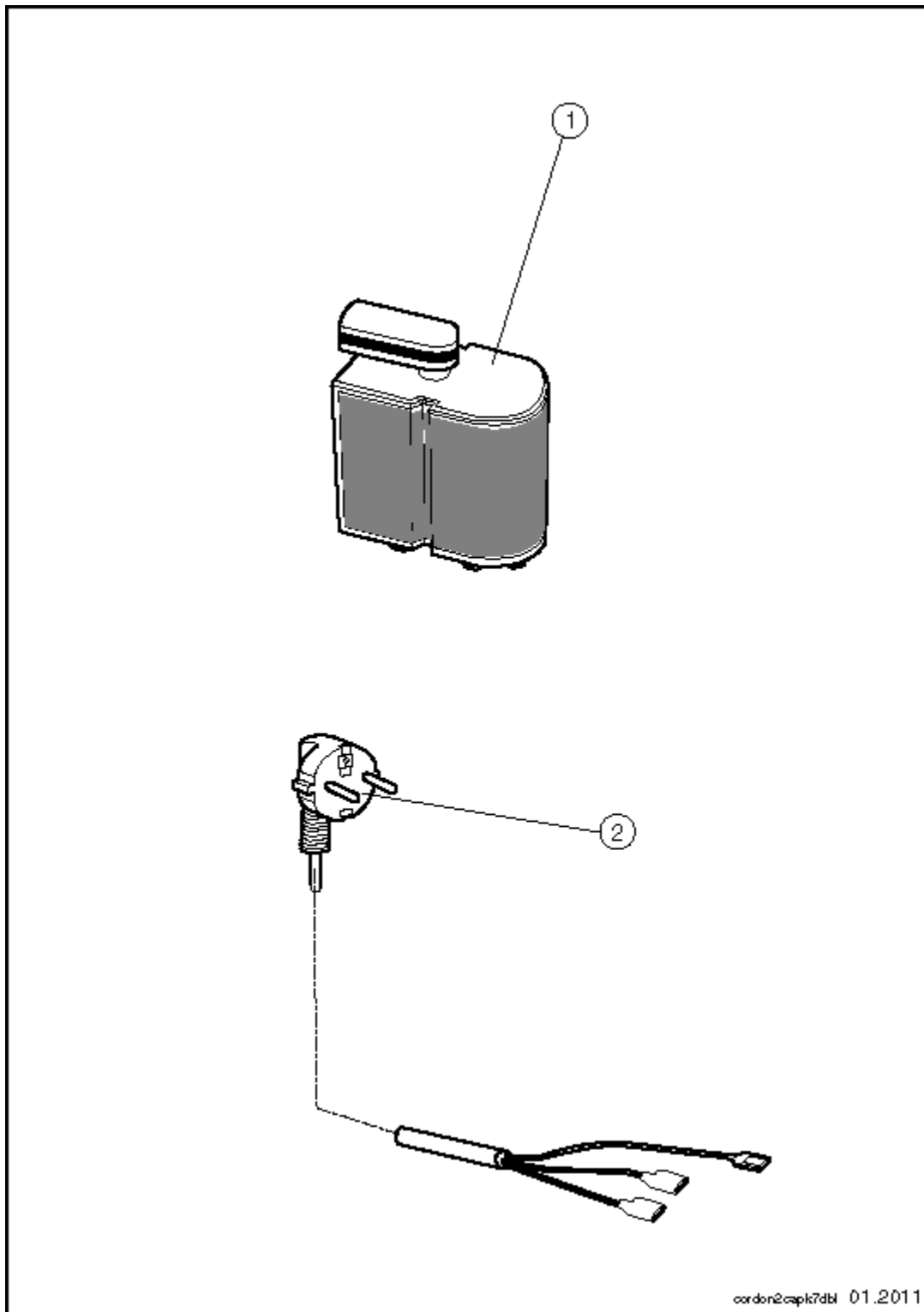

REP	QTE	No ARTICLE	DESIGNATION	
001	1	500676342	CASSETTE DOUBLE EMC	
002	1	500474055	CORDON D'ALIMENTATION FIXE CEE	