

Contents

- 1 *Technical Specifications for Vented / Condenser Dryer*
- 2 *Terra Electronic Clothes Dryer Project*
- 3 *Terra Condenser Dryer Working Principle*
- 4 *Terra Vented Dryer Working Principle*
- 5 *Dryer Programme Tables*
 - 5.1 *Terra (Base) Timed Vented Dryer* *Type 866A0*
 - 5.2 *Terra Vented dryer* *Type 876A1*
 - 5.3 *Terra (Base) Timed Condenser Dryer* *Type 866C01*
 - 5.4 *Terra Condenser Dryer with Senso* *Type 876C11/876C 12 (TankUp)*
- 6 *Door reverseability*

1. Technical Specifications for Vented / Condenser Dryer:

1.1. Product Definitions :

1.1.1. Producer : Arçelik A.Ş.
Tuzla - İstanbul / TÜRKİYE

1.1.2 Model : Terra Air Vented VDE Codes :

Dryers Type	CONTROL	VDE Codes	Customer	Brand	Customer Code :
Air Vented	Sensor	876A1	BEKO DEUTSCHLAND	BEKO	DV 1560
			BEKO FRANCE	BEKO	DV 1560 X
			BEKO PLC	BEKO	DRVS 62 W
				BEKO	DRVS 62 S
				FLAVEL	TDF 162 W
			FLAVEL	TDF 162 S	
			CIS-E.EUROPE-SPAIN	BEKO	DV 1560
			FAGOR BRANDT	EDESA	SE 60 E
				FAGOR	SFF 62
			ISRAEL	BEKO	DV 1560 X
			WEST EUROPE / DENMARK	BEKO	DV 1560
			W. EUROPE / BELGIUM	BEKO	DV 1560 X
	BEKO SPAIN	SAIVOD	STE 6		
		ECRON	EV 1960		
	MEA	SINGER	SD 5500		
	W. EUROPE	FRIAC DE LUXE	DK 6116E		
	Base / Timed	866A0	ARÇELİK PAZARLAMA	ARÇELİK	1660 KT
			WEST EUROPE	BEKO	DV 1160
				SMEG	AS61E
			BEKO DEUTSCHLAND	ALTUS	TA 1000
			BEKO DEUTSCHLAND - EBREGENZ	BEKO	DV 1160
			BEKO FRANCE	BEKO	DV 1160
			CIS-E. EUROPE SPAIN	BEKO	DV 1160
			FAGOR BRANDT	EDESA	SE 60 T
FAGOR				SFE 60	
ISRAEL			BEKO	DV 1161 X	
BEKO SPAIN			ANSONIC	SA 6	
MEA			SINGER	SD 5400	
FAR EAST	EUROPA	ED 116			
CHINA	BEKO	DV 1160			
BEKO PAZARLAMA	BEKO	D 60KB			

:Terra Condenser VDE Codes

Condenser	Sensor					
		876C11	ARÇELİK PAZARLAMA	ARÇELİK	2760 KT	
			BEKO DEUTSCHLAND	ALTUS	TK 1201	
			BEKO PLC	BEKO	DRCS66W	
				FLAVEL	TDF 166 W	
				FLAVEL	TDF 166 S	
				BEKO	DRCS66S	
				CARREFOUR	BLUESKY	BSLE 06
			CIS- EAST EUROPE	BEKO	DC 1560	
			SPAIN	BEKO	DC 1560	
			FAGOR BRANDT	EDESA	SE 60 CBE	
				FAGOR	SFF 62 CB	
		WEST EUROPE / DENMARK	BEKO	DC 1560		
		WEST EUROPE / BELGIUM	BEKO	DC 1560 X		
			BEKO	DC 1560 XS		
		BEKO SPAIN	SAIVOD	STE 6C		
			ECRON	EC 1960		
		BEKO PAZARLAMA	BEKO	D 60 K		
		SPAIN	BRU	ES 1560 C		
		WEST EUROPE	FRIAC DE LUXE	DKC 6316E		
		876C12		WEST EUROPE	SMEG	AS63CS
					Atlas	KT 135/06
	BEKO DEUTSCHLAND - EBREGENZ			BEKO	DCU 1560 X	
	BEKO FRANCE			BEKO	DCU 1560 X	
	BEKO PLC			BEKO	DRCS68W	
				BEKO	DRCS68S	
	CIS- EAST EUROPE			BEKO	DCU 1560	
	SPAIN			BEKO	DCU 1560	
	EBREGENZ			ALTUS	TK 1200	
	FAGOR BRANDT			FAGOR	SFF 62 C	
				FAGOR	SFE 62 C	
	WEST EUROPE / DENMARK			BEKO	DCU 1560	
	Base / Timed	866C01	WEST EUROPE	SMEG	AS62C	
				BEKO	DC 1160	
BEKO DEUTSCHLAND			ALTUS	TK 1100		
CARREFOUR			BLUESKY	BSLC 826		
CIS EAST EUROPE - SPAIN			BEKO	DC 1160		
FAGOR BRANDT			EDESA	SE 60 CB		
			FAGOR	SFF 60 CB		
BEKO SPAIN			ANSONIC	SA 6TC		
SPAIN	BRU	ES 1160 C				
WEST EUROPE	FRIAC DE LUXE	DKC 6216E				

1.1.3 Capacity (Dry load)(kg) : 6

1.1.4 Numbers of Programme (Qty) : max 11

1.2. Dimensions

1.2.1. Height (mm) : 850

1.2.2. With (mm) : 595

1.2.3. Depth (mm) : 540

1.2.4. Venting hose	: Vented model
1.2.4.1. Diameter(mm)	: 100
1.2.4.2. Length (cm)	: 200
1.2.5. Draining hose	: Condenser Model
1.2.5.1. Diameter Outer/Inner (mm)	: 13 / 9
1.2.5.2. Length (cm)	: 122

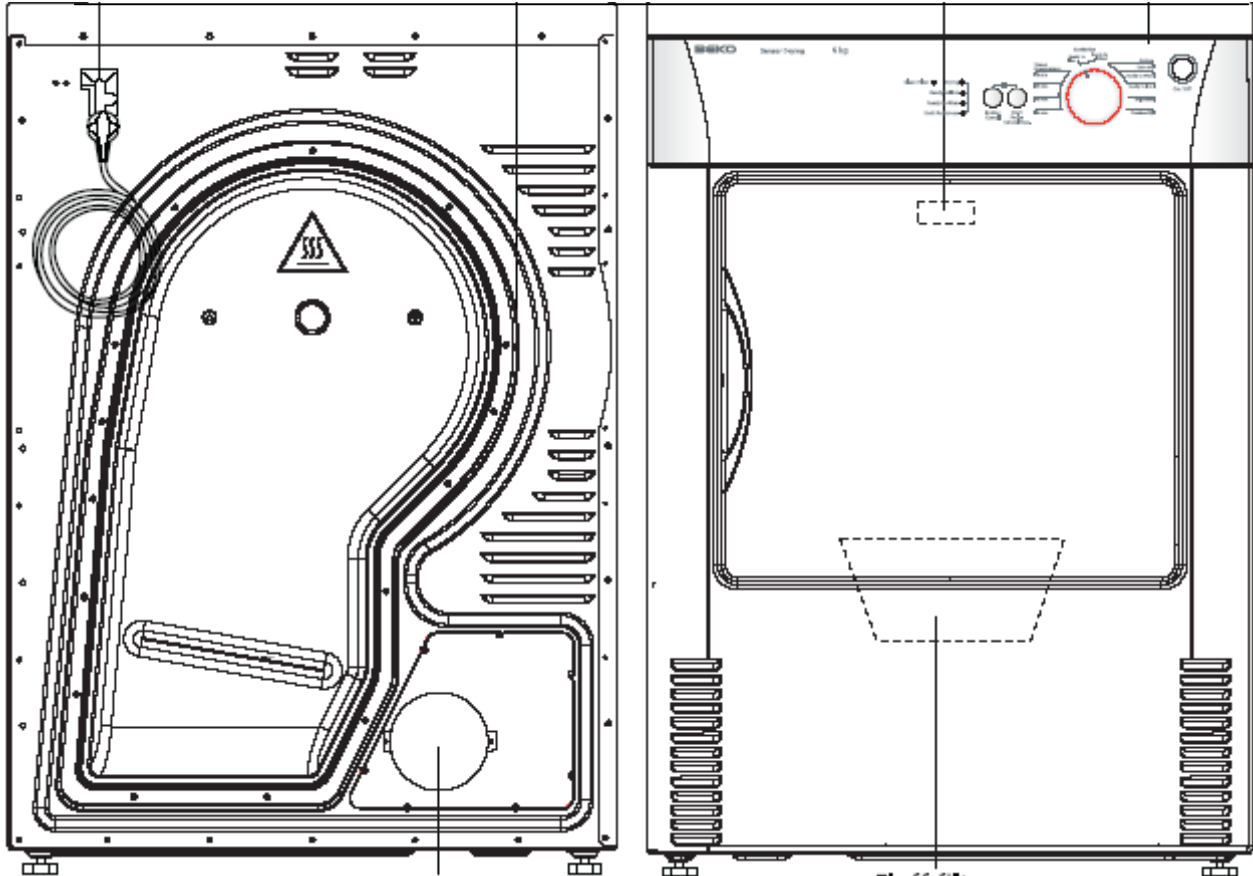

1.3. Packaging

1.3.1.1. Material :	
1.3.1.2. Packaging	: PE bag (Shrink-pack)
1.3.1.3. Reinforcement	: Polystro-foam / Wood
1.3.1.4. Dimensions :	
3.3.1.4.1. Height (mm)	: 890
3.3.1.4.2. With (mm)	: 660
3.3.1.4.3. Depth (mm)	: 585

1.4. Weights

1.4.1. Condenser Model

1.4.1.1. With Packaging (kg)	: 37
1.4.1.2. Without Packaging (kg)	: 35

1.4.2. Vented Model

1.4.2.1. With Packaging (kg) : 31 Vented

1.4.2.2. Without Packaging (kg) : 29 Vented

1.5. Ambient Conditions

1.5.1. Temperature:

Min. : 5° C

Max. : 35° C

1.5.2. Humidity : %95 RH

1.6. Technical specifications

1.6.1. Voltage (V / Hz) : 220-240 V / 50 Hz

1.6.2. Power (kW) : 2,0-2,2 kW

1.6.3. Current (A) : 10

1.7. Power supply Cord

1.7.1.1. Type : 3 x 1.5 mm² Cord Copper wire

1.7.1.2. Isolation : TS 9760 H05V2V2-F 3G1,5mm²

1.7.1.3. Plug : Earthed, PVC injected

1.7.1.4. Length (mm) : 1605

1.8. Motor

1.8.1. Type : 1 Phase Asynchronous

1.8.2. Power (W) : max 250

1.8.3. Main winding(ohm) : 21,5± 7%

1.8.4. Auxiliary winding(ohm) : 21,5± 7%

1.8.5. Motor speed(6 kg loaded) (rpm) : 2750

1.8.6. Drum speed (rpm) : 48 ± 4

1.8.7. Isolation Class : Class : F

1.8.8. Start Capacitor : 8 mF ± %5

1.9. Pump (Only 876C12 TankUP models)

1.9.1. Type : Shaded Pole Asynchronous

1.9.2. Power (W) : 26

1.9.3. Voltage/ Frequency : 230-240 V 50Hz,

1.9.4. Speed : 2300 rpm

1.9.5. Main winding

1.9.5.1. Number of turns : 2300

1.9.5.2. Wire diameter/Class : 0,212 / Class F

1.9.5.3. Resistance (ohm) : 125± 10%

1.9.6. Flow rate (l / min) : 3 - 4

1.9.7. Pump Head (m) : 1

1.10. Heater

- 1.10.1. Type : Open flat wire
- 1.10.2. Nominal Power&Voltage (W) : at 230V 2000 ± %5
- 1.10.3. Resistance (ohm) : 1400 W 1.level (86,44 ohm± %5)
: 600 W 2.level (37,04 ohm± %5)

Safety Note: If the one thermostat or Heater NTC is defective, also please check the motor is running, fan is not broken and V-belt is Ok ,and filter is clean; before starting the appliance.

Security Thermostat (On heater) : 135°C +6,5°C (130°C VENTED)

1.10.4. Thermostat (near Heater) : 110°C (100°C VENTED)

NTC (near Heater; with Sensor) (ohm) : at 25° C, 19 500

1.11. Drum Thermostat : 78°C (63°C VENTED)

Drum NTC (with Sensor model) (ohm) :at 25° C, 19 500

1.12. Housing :

- 3.11.1. Material : Sheet steel
- 3.11.2. Finish : Acrylic Powder paint in Oven

1.13. Drum :

- 1.13.1. Material : Hot dip Galvanized corrosion resistant sheet steel
- 1.13.2. Volume (l) : 110
- 1.13.3. Drying speed (rpm) : 48±4
- 1.13.4. Door max. dimension (mm) : max. 390
- 1.13.5. Process Air flow rate (m3/h) :180
- 1.13.6. Cooling Air flow rate (m3/h) :300-330
- 1.13.7. Maximum Load Capacity :
- Cotton (kg) : 6
- Delicates , Synthetics (kg) : 3

1.14. Control System Specifications :

- 1.14.1. **On/off switch** :250 V, 16 (4)A
- 1.14.2. **Door switch** : 250 V, 3 (1)A or 16(4)A
- 1.14.3. **Overflow switch**
(Condenser model only) : 250 V, 16 (4)A
- 1.14.4. **Condenser security switch** : **250 V, 16 (4)A**
- 1.14.5. **Suppressor Filter** :
- 866C01 : 0,15 µF
- 876C11 & 876 C 12 : 0,47 µF

1.14.6.	Program Timer	: Electronic Control Board 220 -240V , 50 Hz
	866C01	:295
	876C11 & 876 C 12	: 295
1.15.	Auxiliary Functions (Qty)	: max 1
1.15.1.	Buzzer cancel or	
1.15.2.	Low heat	

2 Terra Electronic Clothes Dryer Project

First the increasing demand of dryers business in Europe, second needed a cheap model in our product range and decreasing price in electronic production made this project reasonable. Due to the safety regulations it is better to design all the product range with Electronic.

5 different types of dryer will be launched with this Terra Electronic Clothes Dryer project.

	<u>Production Code</u>	<u>VDE Code</u>
1. Terra Time based Air Vented Clothes Dryer	DV 1160	866A0
2. Terra Air Vented Clothes Dryer with sensor	DV 1560	876A1
3. Terra Condenser Clothes Dryer	DC 1160	866C01
4. Terra Condenser Clothes Dryer with sensor	DC 1560	876C11
5. Terra Condenser Clothes Dryer with sensor (Tank Up)	DCU 1560	876C12

3 Terra condenser Dryer Working Principle

(Condenser Models)

Working principle for a condenser dryer

The big difference compared to the venting dryer is, that the condenser dryer has two air circuits.

One hot air circuit in closed circulation. The air coming out from the drum has, after taking over the humidity from the laundry, a relative humidity near to 100%.

This hot and humid air passes a condenser, cooled by air. In the beginning, cooling is done without condensation, till the saturation temperature of the mix water-steam is reached. When this temperature is reached, cooling is assisted by condensation and the water is recuperated in a tank which has to be drained by the consumer at the end of the cycle.

A fan circulates the saturated air at the outlet from the condenser to the heating element. At the contact with the resistance, the air is heating up and enter again to the drum.

A cool air circuit, where the ambient air is heated up passing the condenser and being in contact with the hot air in the condenser tubes. This air is evacuated through the dryer body. The used exchanger is an air-air condenser with crossed circuits, which are perpendicular each to other. The condenser contains tubes and can be removed easily from the dryer. These tubes are passed by the hot air circuit and are cooled by the cool air circuit at their outside.

This type of dryer permits to dry laundry without having humid air in the room. The Dryer machine is configured to operate at 230V AC. Voltage and current requirements are specified on the rating plate located upper side of the door opening.

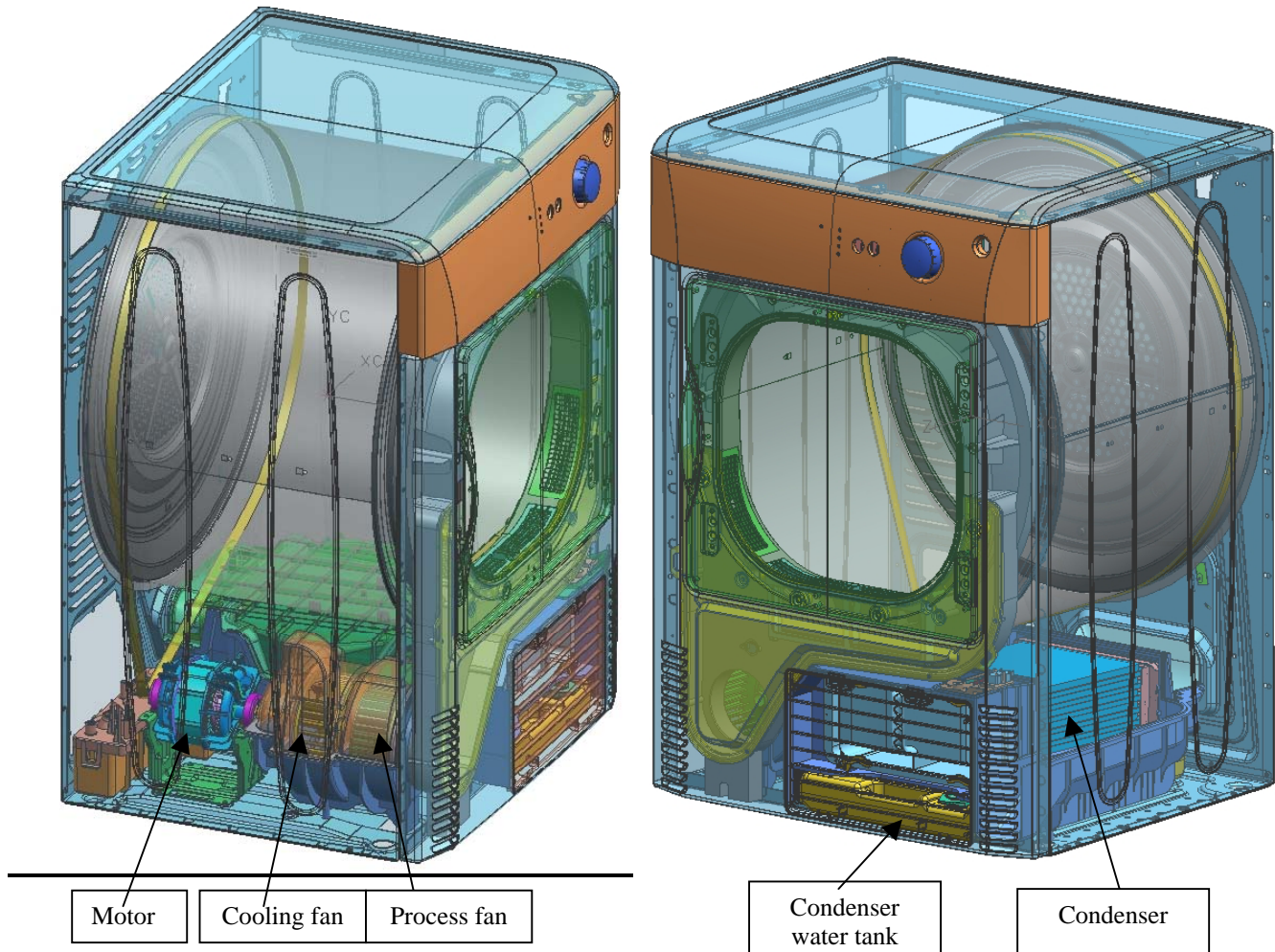

2.1 Terra Vented dryer Working principle

The ambient air is heated passing the resistance and pass the drum where he « loads » humidity. Humid and hot air is evacuated(vented) by the fan located in the outlet.

During drying phase, the drum is rotating at a speed that gives a fully occupancy of the laundry in the drum. The motor is running also the fan(not only the drum), to evacuate the hot and humid air from the drum.

Air vented dryer uses ambient air. It take the air and pump through heater area. Heated air, coming from the back side of drum meets with the clothes. As shown the picture air goes to the process fan through the lint filter area. This air with the temperature of 45-55 C and with the humidity.

The Dryer machine is configured to operate at 230V AC. Voltage and current requirements are specified on the rating plate located upper side of the door opening.

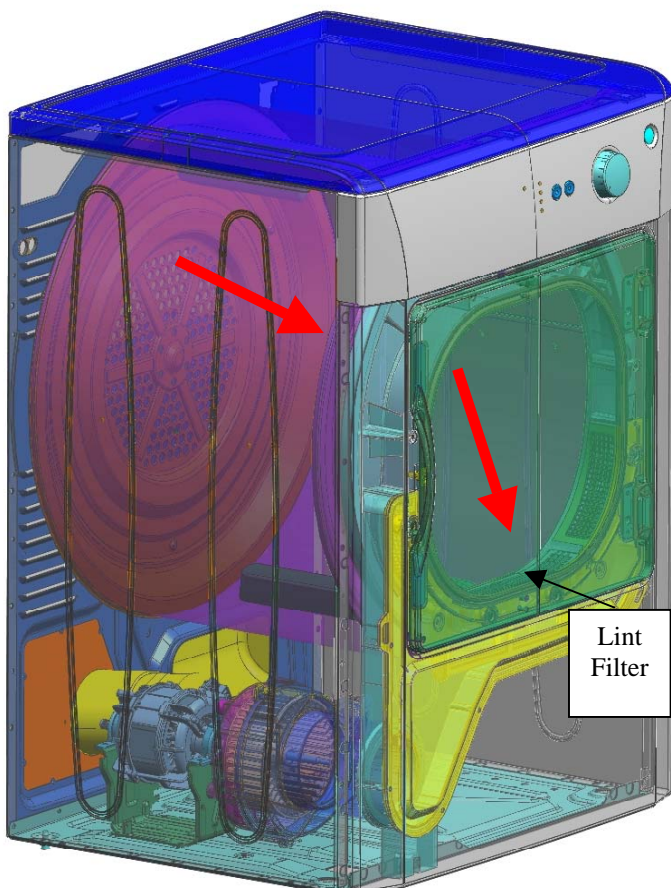

3 Installation, Programme's and User Manual

The proper location

For drying the appliance requires a sufficient supply of clean, cool room air. Operate the appliance only in well ventilated, low dust rooms. Do not block or cover the appliance's vent slots. Do not operate appliance in locations where there is a danger of freezing. Some parts contain water and may be damaged by frost.

The floor must have a sufficient load bearing capacity! If, for example, you are stacking a washer and the dryer, this combination can – when loaded – reach a total weight of 160 kg.

Important:

- Place appliance on an even an level floor only.
- Do not stand appliance on the power cable.
- Keep at least 1 cm distance to walls or other furniture.

Technical Specifications / Energy Consumption Condenser models

Load capacity (dry weight)	max. 6.0 kg	
- Cottons	max. 3.0 kg	
- Synthetics	max. 6.0 kg / 3.0 kg	
- Fluff/Refresh		
Dimensions	85.0 cm / 82.0 cm	
• Height / height for built-under installation		
• Width - Depth / depth for built-under installation	59.5 cm 54 cm	
• Height adjustment of feet	0.5 cm	
Weight, unpacked	approx. 35 kg	
Consumption 1)	for spinning speed	Energy For Condenser
• Cottons linen cupboard dry 2) 3)	800 min-1	: 3.84 kWh
• Cottons ironing dry 2)	800 min-1	: 3.40 kWh
• Synthetics linen cupboard dry 2)	1000 min-1	: 2.00 kWh

Technical Specifications / Energy Consumption Air Vented Models

Weight, unpacked	approx. 29 kg		
Consumption 1)	for spinning speed	Energy For AV	Energy For Condenser
- - Cottons linen cupboard dry 2) 3)	1000 min-1	: 3.39 kWh	: 3.84 kWh
- - Cottons ironing dry 2)	1000 min-1	: 2.90 kWh	: 3.40 kWh
- - Synthetics linen cupboard dry 2)	600 min-1	: 1.80 kWh	: 2.00 kWh

1) Standard values, determined under standard conditions. Depending on spin speed, textile type and ambient conditions a deviation of up to 10% is possible.

2) Test programme according to DIN EN 61121.

3) Standard programme for energy identification label.

Preparation and start

1. Sort the laundry according to cottons, synthetics, etc.
 2. Put laundry in the drum and close the door.
 3. Turn the appliance on by pressing On/Off button
 4. Set the selector desired time.
 5. Press the Start /Pause/Cancel button.
- Program starts and indicator is on.

Canceling a program

Do not turn appliance off during the heating phase (process indicator is on). Risk of heat accumulation!

1. First stop the running program press the >Start /Pause/Cancel< button.
2. Then press start button for 2 seconds to cancel the program

3. Set the program selector to Freshen up.
4. Press the Start /Pause/Cancel button.
5. Wait for the program cycle to end.

Adding more laundry

This makes only sense at the beginning of a drying cycle, otherwise the result will be a mixture of not quite dry and too much dried textiles.

1. Press Start /Pause/Cancel button. Start/Stop indicator will flash.
2. Put laundry in the drum and close the door.
3. Press the >Start /Pause/Cancel < button. Start/Stop indicator will be on.

Program end

The program cycle is completed when the indicators End/Anti-Creasing and Clean filter are illuminated. Throughout the anti-crease stage the indicator End/Anti-Creasing flashes. The program can then be

ended at any time.

1. Set the On/Of button off position.
2. Open door, remove laundry, check tumble for foreign objects.

3. After every drying cycle :

Clean the fluff filter (see "Fluff filter").

4. When required

Clean housing and fascia using a soft cloth and a mild soap; wipe dry with a soft cloth. Do not use scrubbers and scouring powders! They will damage the plastic and painted body parts.

When the door is opened during the program, the program will be paused automatically and the light on the start button will flash. The start button must be pressed again to continue the program.

Changing the program

When changing to a **different** program the running program must be stopped first.

To do so the >Start /Pause/Cancel< button must be pressed for 2 sec. in order to cancel program.

Laundry final drying

If the dryness level is not satisfactory Set the program selector to one of the timed program 40min, 20min or 10min. In order to reach right dryness level you can use additional final drying.

Leveling

Cleaning the Fluff Filter :

:Fluff balls are rubbed off by wearing the clothes - not by drying. When drying, these fluff balls are trapped in the fluff filter. Normally, laundries are much more worn out by everyday usage and washing compared to drying. It is absolutely necessary to clean the fluff filter **after every drying cycle**:

To clean the fluff filter:

1. Open the door.
2. Pull out the fluff filter.

- Adjust feet until the appliance is level and does not rock. Checking with a spirit level is recommended.

Important:

- Adjust by the feet only, do not use wooden wedges or similar. Never remove the feet!

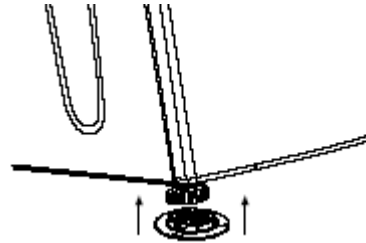

Two rubber friction pads are supplied with your tumble dryer in case required to stop the appliance moving on a slippery or smooth surface. To fit friction pads underneath the height adjustable front feet, gently tilt the tumble dryer backwards as shown in the diagram and push the pads firmly on the feet. Check that the product is level and re-adjust leveling if required.

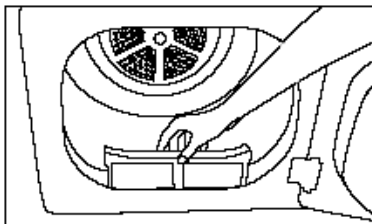

3. Open the filter by pushing handle.

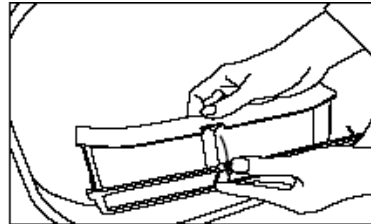

4. Carefully remove the fluff balls - by hand or with a soft, dry cloth.

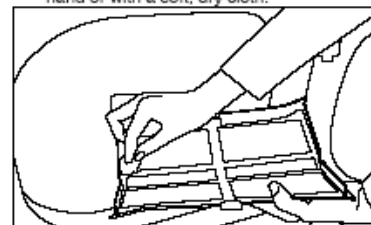
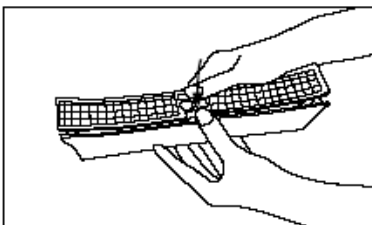

5. Insert fluff filter the right way round.

The Programme times are described below:

The Programme times for the Air Vented type			Spun at	
White/colored cottons	Programme	Load	800-900 rpm	1000-1200 rpm
Long wearing cotton and linen textiles	Linen cupboard dry	6 kg	130'	110'
		3 kg	80'-110'	60'- 80'
	Ready to Iron	6 kg	110'	80'-110'
		3 kg	60'- 80'	40'- 60'
Easy-care	Select "Low Heat" button		600 rpm	800 rpm
Synthetics (polyester, polyamide); mixed fabrics (with cotton)	Linen cupboard dry	3 kg	60'- 80'	40'-60'
		1.5 kg	40'-60'	20'-40'

The Programme times for the Condenser type			Spun at	
White/coloured cottons	Programme	Load	800-900 rpm	1000-1200 rpm
Long wearing cotton and linen textiles	Linen cupboard dry	6 kg	150'	130'
		3 kg	80'-100'	60'- 80'
	Ready to Iron	6 kg	130'	100'-130'
		3 kg	60'- 80'	60'- 80'
Easy-care	Select "Low Heat" button		600 rpm	800 rpm
Synthetics (polyester, polyamide); mixed fabrics (with cotton)	Linen cupboard dry	3 kg	100'-130'	60'-80'
		1.5 kg	30'-60'	30'-60'

Important Safety Information

It is most important that this instruction book should be retained with the appliance for future reference. Should the appliance be sold or transferred to another owner, or should you move house and leave the appliance, always ensure that the book is supplied with the appliance in order that the new owner can get know the functioning of the appliance and relevant warnings. These warnings have been provided in the interest of safety. You must read them carefully before installing or using appliance.

INSTALLATION

- This appliance is not intended for commercial use it is a household clothes tumble dryer.
- This appliance is heavy. Obtain assistance when moving it.
- Any electrical work required to install this appliance should be carried out by a qualified electrician or competent person.
- Care must be taken to ensure that the appliance does not trap electrical supply cable.
- The machine never situated on a carpeted floor, please adjust the feet in order to allow air to circulate freely.
- If the tumble dryer placed on a washing machine, must be used stacking kit. (optional accessory)
- This tumble dryer is designed to be vented to the open air. It should have its own ventilation system which should not be joined with any other ventilation system connected to any other appliance.

CHILD SAFETY

- This appliance is designed to be operated by adults.
- Children should not be allowed to tamper with the controls or play with the product.
- Pets and children are known to climb into tumble dryers. Please check your drum before use.
- Keep all packaging well away for children.

OPERATION SAFETY POINTS

- Do not overload the Dryer. (See program chart)
- Clothes which are dripping wet should not be placed in the dryer. Spin them again in the washing machine.
- As some bulky duvets and eiderdowns should be dried in large commercial machines because of their bulk, check with the manufacturer of the item if it is suitable for drying in a domestic machine, even if the dry weight of items is within the limit advised.
- Please make sure that no gas lighter have accidentally been left in pockets of garments to be tumble dried.

Danger of Explosion

- Never tumble dry items that have been in contact with inflammable solvents (petrol, methylated spirits, dry cleaning fluid and the like). As these substance are volatile, they could cause an explosion. Tumble dry only items washed with water.

Risk of Fire :

- Items that have been spotted or soaked with vegetable or cooking oil constitute a fire hazard and should not be placed in the tumble dryer.
- In order to avoid danger of fires caused by excessive drying, do not use to dry the following items:

- Cushion, quilts and similar stuffed items (These items accumulate heat)
- Items containing the rubber foam or materials similar to rubber foam.
- Leave the door slightly ajar when the dryer is not being used. This allows the seal to be preserved.
- Clean the fluff filter after using tumble dryer. To prevent fire risk, do not use the dryer if the fluff filter is damaged.
- Never attempt to repair the appliance yourself! You could endanger your own life and the life of other users!

Only authorized electricians, such as our service technicians, are permitted to repair electric appliances.

Electrical connection

- Connect the appliance to a properly installed earthed outlet, protected by a fuse of adequate capacity.

Make sure that you have an earthed power outlet socket rated at 13 amps (min.). (Max. 16 amps.)

Voltage 230V ~ 50 Hz

Connected load 2200 W

Fuse protection 10A

Attention!

If you use your machine as built-in, the socket must be reachable after installation, or a separate switch (which can disconnect the two poles) must be used in the installation.

For a permanent connection, a master switch with at least 3mm contact clearance must be used.

Connect the power cord to the appropriate electrical socket with an equivalent current rating indicated on the rating plate at the front of the machine inside the front door.

Electrical requirements

Before you insert the plug into the wall socket make sure that the voltage and the frequency shown in the rating label corresponds to your electricity supply.

We recommend that this appliance be connected to the mains supply via a suitable switched and fused socket in a readily accessible position.

Connect the appliance to a properly installed earthed outlet, protected by a fuse of adequate capacity.

Important:

- The connection must conform to the applicable regulations in your country and of your local Electricity Board.
 - The power cable plug must be accessible after installation.
 - For a firmly fixed connection a master switch with at least 3 mm contact clearance must be used.
- Note down the appliance's model and identification number from the rating label, in case you need help from customer service.
- The stated voltage must match with your mains voltage.
 - Connection by extension cables or trailing sockets is not permitted.
 - When connecting to the mains, make sure the On/Off button is in Off position.

Important

- The connection must conform to the prevailing

regulations in your country and those set by your local

Electricity Board.

- The power cable plug must be accessible after installation.

A damaged power cable must be replaced by an authorized qualified electrician. Until the appliance has been repaired it must not be operated!

Note down the appliance's model and identification number from the identification plate showing the voltage in case you need help from Customer Service.

- The voltage shown must match your mains voltage.
- The appliance must not be connected via extension cables or multiple sockets.

Disposal

Where to leave the packaging?

The plastic wrapping must not get into the hands of children! Risk of suffocation!

The packaging is made of materials which can be recycled.

- Separate the packing material by type:
 - Styropor® parts and plastic wrapping go to a valuable substance collection point;
 - battens go into bulky refuse.

The packaging is not to be disposed of in the regular household refuse!

What to do with the old appliance?

Dispose of your old appliance in an environmentally friendly manner.

- Ask your dealer or your local refuse collection service how to best dispose of your old appliance. Before giving the appliance into bulky refuse, disconnect it from the mains, cut off the power cable and disable the door lock – so children will not be endangered.

Installation

The proper location

For drying the appliance requires a sufficient supply of clean, cool room air.

Do not operate the appliance together with furnaces (gas-, oil-, coal-fired) or fireplaces. The airflow may aspirate their exhaust fumes, withdraw oxygen and extinguish flames.

Poisoning hazard!

Operate the appliance only in well ventilated, low dust rooms. Do not block or cover the appliance's vent slots.

The floor must have a sufficient load bearing capacity! If, for example, you are stacking a washer and the dryer, this combination can

– when loaded – reach a total weight of 160 kg.

Important:

- Place appliance on an even and level floor only.
- Do not stand appliance on the power cable.
- Keep at least 1 cm distance to walls (at rear side 2 cm) or other furniture.
- Do not restrict the floor clearance through deep pile carpets, strips of wood or similar.

In order for quiet and stable operation, the machine should be located correctly and leveled. Your machine comes with adjustable feet. If the machine is

unstable, loosen the plastic screw or unscrew the adjustable foot until the machine is leveled perfectly.

Air Vented Models Only:

Your machine comes with single (100 mm diameter and 2 meter long flexible air ventilation hose). Connect the flexible air ventilation hose, using the given adaptors. For proper operation, the hose should not be hard bent.

Before any operation of the machine check the following:

- Is the flexible air ventilation hose properly installed?
- Is the machine plugged into the mains outlet?
- Has the fuse been checked?
- Is the front door closed?

Vent exhaust air out of doors!

The appliance has one exhaust outlets at the rear.

The exhaust air should not be simply led into the room, since the high humidity may cause long term damage to walls and furniture.

•Connect the vent tube with the straight to the exhaust air outlets.

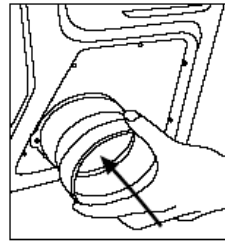
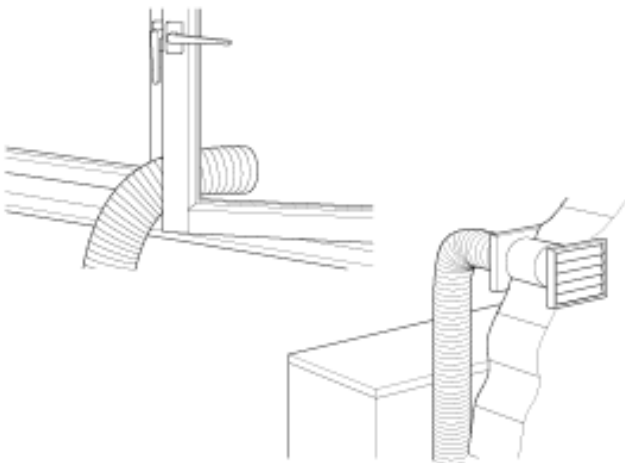

Fix adapter by pushing into machine.

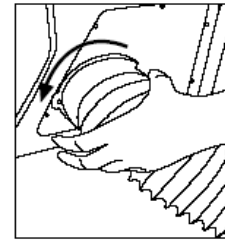

Connect hose by screwing.

 It is not recommended to install vent hose like shown on the picture.

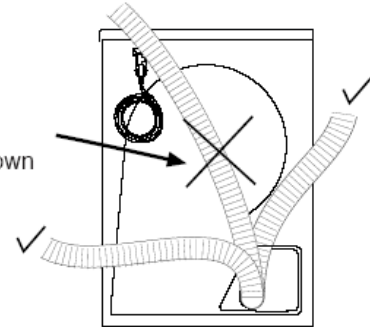

Fix adapter by pushing into machine. Connect hose by screwing. It is not recommended to install vent hose like shown on the picture.

The vent tube

- can be run through an open window install to the outside;
- can be connected to a wall-mount vent.

The exhaust air must not be led into flues or chimneys of fireplaces. Check with your chimney sweeper or heating engineer.

• Instead of the vent tube vent pipes can be used.

The diameter should be at least 10 cm. engineer.

• Tube or pipe, respectively, should be routed in the straightest and most direct path outdoors, i.e. with the fewest number of elbows and turns, as these hamper airflow.

• The maximum length of a straight routed tube/pipe is given in the chart below.

• For each elbow and other obstructions the respective value shown is to be deducted from the maximum length.

	Hose	Pipe
Max. length	4.0 m	5.0 m
less...		
1 elbow 45°	-1.0 m	- 0.3 m
1 elbow 90°	-1.8 m	- 0.6 m
1 elbow 90° short turn		- 2.7 m
1 wall-mount vent *	-2.0 m	- 2.0 m

* with automatic louvers

Condenser Models Only:

Condensed water container

When drying, water is separated from airstreams of the moist laundry ("condensate"). This water is collected in the condensed water container. The condensed water container needs emptying – **after every drying cycle**, or if during the drying cycle the **> Tank Full <** indicator flashes; in that case the program stops. Do not pull the condensed water container out while the program is running. The condensed water can also be drained permanently by means of the drain hose supplied into a siphon trap or any other drain (see "Drain hose connection").

Emptying the condensed water container:

1. Pull condensed water container carefully out off the housing; hold the rear with the other hand.
2. Open the condensed water container's closure.
3. Pour the water out.
4. Remove any fluff balls from the closure, if present. Close the closure.
5. Slide the condensed water container fully in. Condensed water is no drinking water! However, after filtering (through a coffee filter) it can be used in a steam ironer or air humidifier.

Condenser

In the air cooler ("Condenser") the moist, warm air stream is cooled by drawn-in cold room air, causing the water to separate.

To clean the condenser:

1. Open the door. Wait for the appliance to cool down.
2. Open service door latch. The service door will open. Then turn the locking level
3. Pull the condenser out at the handle.
4. Rinse condenser – vertically and horizontally thoroughly under running water. Let water drain thoroughly.
5. Push condenser – with the lettering embossed at the edge facing up – fully in, then fix the locking level.
6. Close the service door.

Sensor ribs

At the front, on the inside of the drum are moisture sensors, signaling to the appliance when the textiles are dry.

To clean the sensor ribs:

1. Open the door. Wait for the appliance to cool down.
2. Wipe all sensor ribs with a soft cloth moistened with vinegar. Wipe dry with a soft cloth

Programs

Time selection knob

The program selector can be turned either clockwise or counter-clockwise.

Pushing the On/Off button, the appliance is **turned on**; the program, however, will **start** only when the **>Start<** button is pressed.

When changing to a **different** program the program must be; stopped first; in that case the Start/Stop/Cancel button must be pressed for 2 sec. in order to cancel program.

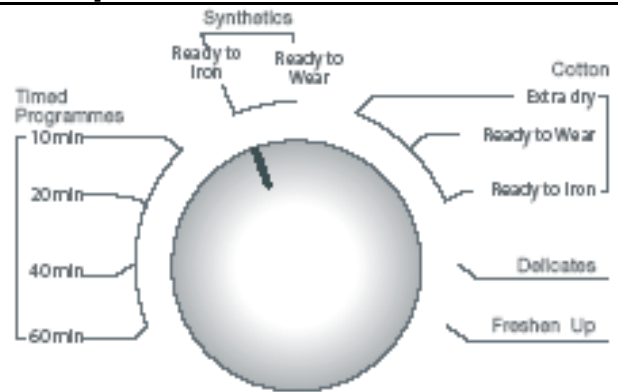

For detailed information about the individual drying times, refer to the "Program table". Always choose a program suitable for the textile type. Observe the care symbols shown on the garment labels!

Standard programme's

Depending on the textile type, several standard programme's are available:

– Cottons:

Drying at high temperature.

– Easy - care:

Drying at reduced temperature. Time programme's offers different drying levels to be chosen.

Drying level	Result
Extra dry*	thick, multi-layer textiles dried ready for the linen cupboard
Linen cup-board dry	regular textiles: dried ready for the linen cup-board
Ironing dry	requiring regular ironing

* only for White/colored cottons

Select drying level only as high as absolutely necessary. This will treat the textiles with care and limits the energy consumption.

Terra Base / Timed Air Vented					Remained moisture %	
Dryness Level	Dry Load	Initial moisture amount %	Duration	min.	max.	
Cotton Cupboard Dry	3,0 Kg	60%	60 min.	-5%	5%	
		70%	80 min.	-5%	5%	
	6,0 Kg	60%	100 min.	-3%	3%	
		70%	130 min.	-3%	3%	
Cotton Iron Dry	3,0 Kg	60%	40 min.	4%	20%	
		70%	60 min.	4%	20%	
	6,0 Kg	60%	80 min.	8%	16%	
		70%	100 min.	8%	16%	
Synthetic Cupboard Dry	3,0 Kg	40%	60 min.	-3%	3%	
		50%	80 min.	-3%	3%	

The program of 130' is Energy declaration program of EN61121, in order to reach right energy class this programme adjusted as 128'+2' (Airing), total duration is 130 minutes.

Terra Base / Timed Condenser				Remained moisture %	
Dryness Level	Dry Load	Initial moisture amount %	Duration	min.	max.
Cotton Cupboard Dry	3,0 Kg	60%	80 min.	-5%	5%
		70%	100 min.	-5%	5%
	6,0 Kg	60%	130 min.	-3%	3%
		70%	150 min.	-3%	3%
Cotton Iron Dry	3,0 Kg	60%	60 min.	4%	20%
		70%	80 min.	4%	20%
	6,0 Kg	60%	100 min.	8%	16%
		70%	130 min.	8%	16%
Synthetic Cupboard Dry	3,0 Kg	40%	80 min.	-3%	3%
		50%	100 min.	-3%	3%

Tumble dry only textiles labeled accordingly. For **extreme sensitive textiles** the use of a laundry bag is recommended.

Application:

1. Before loading dryer all small and fresh stains must be removed.
2. Introduce 1 to 4 pieces into the drum or first into the laundry bag.
3. Select a time program. And low heat option should be chosen.
4. When program is finished, take laundry pieces out from the drum or the laundry bag and place them over a hanger to avoid creasing.

Fluff/Refresh:

For refreshing or airing, for all types of fabrics.

Timed programme's

For final drying or airing your washing several timed programme's are available.

– 60min, 40min, 20min, 10min

Drying at a reduced temperature; the drying cycle will always end after the chosen time has elapsed, irrespective of the drying level.

Anti-crease

If the textiles cannot be removed from the dryer after completion of the drying cycle, pressing this button will separate and smooth your drying to reduce creasing.

Throughout this **anti - crease stage** the drum rotates briefly every 60 seconds for 2 hours.

Special programme's

A special programme is also available:

Delicate Program

Extra gentle drying at an reduced temperature and limited programme duration of approx. 20 minutes.

Textiles such as fine textiles, delicate underwear and accessories like scarf can be dried by this programme.

Optional Functions

Low Heat (Only Timed models)

Low-Heat button reduces the heating power to the lower values. This function should be used for Synthetic and delicates. When you select this option, make sure that low-Heat indicator is on.

Buzzer Cancel(Only sensor models)

At programme end and throughout the anti-crease stage (see above) a buzzer sounds. If this is inconvenient to you, press this button to mute.

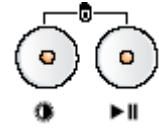

There is no need to press the button for the next drying cycle, because the dryer remembers this setting. You may remove the textiles at any time and end the programme.

Child-lock (Both sensor and Timed models)

With the child lock the appliance can be made child-proof. This function can be set during the programme or in non-usage and standby.

To activate the child lock:

Press and hold both buttons indicated by the arrows for approx. 3 seconds, until the child lock activated and one of the progress indicator will begin flashing. The child lock will deactivate all the buttons except the On/Off button.

To deactivate the child lock:

Press and hold both buttons indicated by the arrows for approx. 3 seconds, until the child lock deactivated and one of the progress indicator will stop flashing. Child lock does not prevent opening the door.

Programme progress indicator

This row of indicators indicate the progress of the running programme.



When you set a programme and press the start button, Start/Stop and one of the indicators will light indicating that the program started. Flashes while Child -lock is active. When the programme is running, one of the indicators is **illuminated** indicating approximate remain time.

End/Anti-Creasing

– is illuminated when the programme end is reached flashes while the anti-crease stage is active.

Indicator lamps

Clean Fluff Filter

– is illuminated at programme end to remind you to clean the fluff filter (see "Fluff filter").

If **Clean Fluff Filter** indicator is flashing during the programme see "Trouble shooting".

The right amount

• The maximum load capacity depends on the textile type and the corresponding drying programme. Please note the information given in the "Programme Table"! Overloading the drum has an adverse effect on the drying result. Always try to utilise the maximum load capacity.

Clothes

Blouse Cotton	150 g	5 oz
Dress Cotton	500 g	1 lb 2 oz
Others	350 g	12 oz
Jeans	700 g	1 lb 6 oz
10 nappies	1000 g	2 lb 3 oz
Shirt Cotton	300 g	10 1/2 oz
Others	200 g	7 oz
T-Shirt	125 g	4 1/2 oz

Household Items

Duvet Cover(Double)	Cotton	1500 g	3 lb 5 oz
	Others	1000 g	2 lb 3 oz
Large Tablecloth		700 g	1 lb 6 oz
Small Tablecloth		250 g	9 oz
Tea Towel		100 g	3 1/2 oz
Bath Towel		700 g	1 lb 6 oz
Hand Towel		350 g	12 oz

Single Sheet	350 g	1 lb 2 oz
Double Sheet	500 g	12 oz

When operating tumble dryer the room temperature must be between +5 C and +35 C. It is not recommended to load above this level. Overloading the Tumble dryer may result in clothing damage.

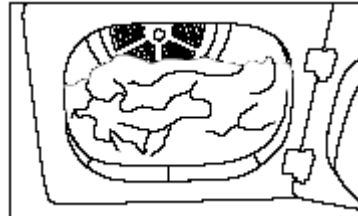

For guidance on maximum loads please refer to the Operation Instructions ! When drying large items such as sheets, we recommend you periodically stop dryer to redistribute load.

Before Calling Service / Trouble Shooting

If you notice...	check...
Appliance cannot be turned on or programme does not start	<ul style="list-style-type: none"> • Programme selected? Start< button pressed? • Door properly closed? • Power cable plug plugged in? • Mains fuse has blown in your home. • Condenser service door opened? Close properly and check the locking latches?
Appliance does not react to input	<ul style="list-style-type: none"> • Child lock activated? If fault persists: unplug, wait a few seconds before plugging in again. • Condenser service door opened? Close properly and check the locking latches?
Indicator 'End (or '0')' flashes (for 2h)	Anti-crease stage is active (duration 2 hours). Turn appliance off and take the laundry out.
Indicator 'End (or '0')' is on.	Programme end reached. Turn appliance off and take the laundry out.
Programme stops without apparent reason	<ul style="list-style-type: none"> • Door is opened? Press the >Start< button. • Did a power failure occur? Press the >Start< button. • Condenser service door opened? Close properly and check the locking latches?
Drum interior light (depending on model) does not work	<ul style="list-style-type: none"> • Lamp faulty? Contact customer service.
Laundry too moist or drying time too long	Drum overloaded? See "Programme table". Make sure of good ventilation. <ul style="list-style-type: none"> • Check vent slots. Check vent tube and wall mount vent, if necessary. • Clean fluff filter, Clean drum ribs. Finish dry with a suitable timed programme. • Check mains supply voltage ?
Indicator Tank Full is on	<ul style="list-style-type: none"> • Drain the tank and push the start button.
Textiles are shrunk, felted, damaged	Dry only textiles labeled suitable for tumble drying. Dry only with a programme suitable for the particular textile type.

Mechanical Parts (Dynamic System):

The main motor is attached to the chassis with four special self threaded screws. In Order to drive drum a poly-v belt is used between the motor pulley and drum. There was used a elastic belt . The drum is made of galvanized sheet steel. The drum group is mounted into the front bearing house and rear bearing steel bracket, which is located rear panel. The heater is mounted to the rear panel with one screws.

Attention : It is advised that the Elastic Poly-V belt will be assembled max 3 times. Due to damage on the belt on assembling, after 3 times please change the Poly-V belt also.

Temperature Sensor NTC (Sensor Model only)

Two NTC temperature sensor are used on electronic controlled dryers, one is located after the door filter, other is located in the heater.

As the temperature of the surrounding of NTC increases, its resistance decreases. At fixed temperature, NTC will always have a specified resistance within the tolerances. With the aid of this principle it becomes possible to have an operation without using a mechanical thermo-stop. The heater operates until the desired temperature is reached. In this way, the selected program completes properly each time in accordance with the program set and auxiliary function neither selected and is nor influenced by air temperature etc.

Humidity sensor:

Humidity level will be measured by the resistance of clothes. With this property of the humidity sensor, it is possible to check and control the humidity level precisely. It is driven by micro.

Heater:

The open flat wire type heater is completely driven by the 2 relays. A mechanical manual resettable thermostat is used on these dryers heater, in order to provide IEC safety rules accordingly. This manual resettable thermostat cut the heater power at 160°C. This thermostat can be resetted at -35°C only, so it is not advised to use after a failure.

A 2000-watt 2 circuit open Wire type heater is used. There are two thermo-fuses on the heater. If the heater runs without airflow, safety thermostat cut off, and thus this heater cannot be used again. The heater is energized only when there is air flow, every time heater relays will be on after 2 seconds of the fan movements. When the desired temperature is reached, electronic control card reads the resistance of NTC and if the prescribed resistance (and hence temperature) is reached, the heater is switched off.

Safety Note: If the one thermostat or Heater NTC is defective, also please check the motor is running, fan is not broken and V-belt is Ok ,and filter is clean; before starting the appliance.

Door lock:

Locking and unlocking mechanism of the door lock used in the Dryer is a mechanical type of the door lock. When the door pushed, the lock is locked and the door is closed. When the pull from the handle of the door, it will be open with a force. Maximum opening force should be less than 70 N.

Door Micro switch :

The main power is connected over the door switch to the motor and main board. When the door is open, the contacts of the motor are open, so the motor is stopped. or when the door is closed, but the dryer will not operate, according to the EN&IEC safety rules you have to press the Start button.

Program apparatus:

The programmer is an electronic card. The electronic card controls the dryer main motor at constant speed and drives the pump by a relays . Manage the program steps. At the sensor model read the temperature from NTC and humidity level from the sensor system, and decide activate or deactivate heater. Heater is also driven from the relay of the electronic card. All of the electronic components of the dryer are managed by electronic card.

Terra Base /Timed Electronic Cards and sockets

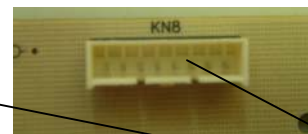
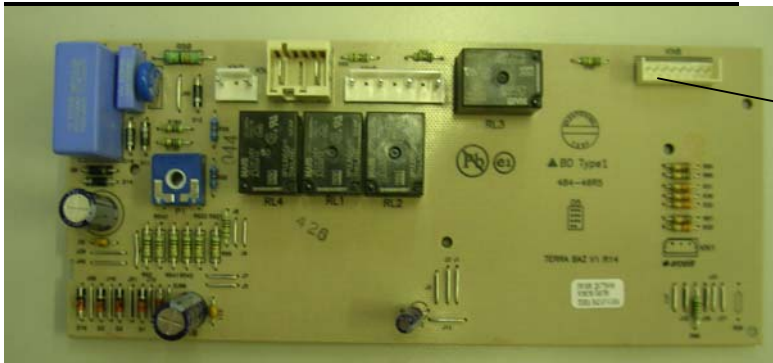

Programming socket

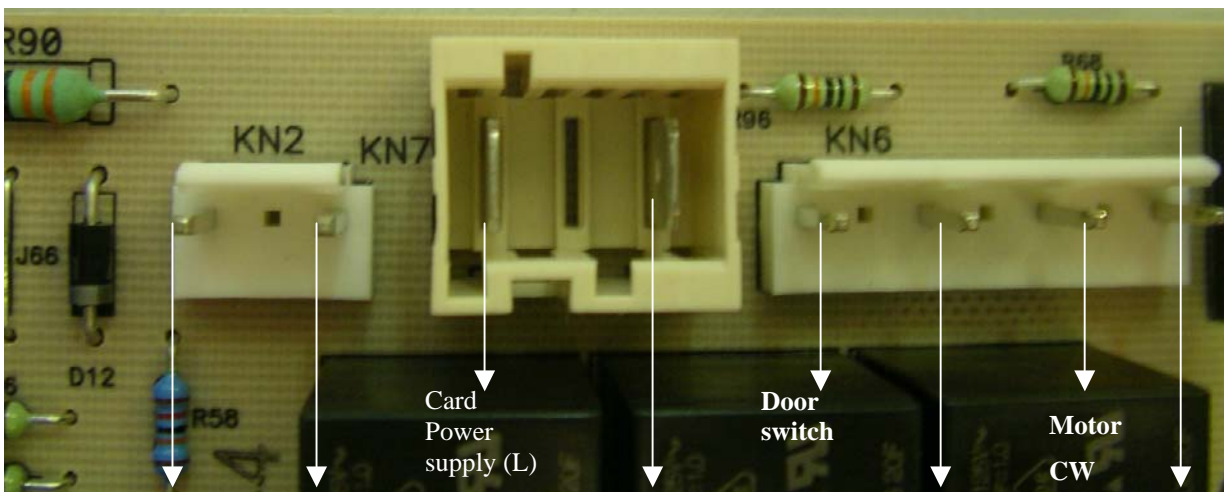

Card power supply (N)

Heater 2 (600 W)

Heater 1 (1400 W)

Overflow switch

Motor CCW

TERRA SENSOR ELECTRONIC PCB CHART:

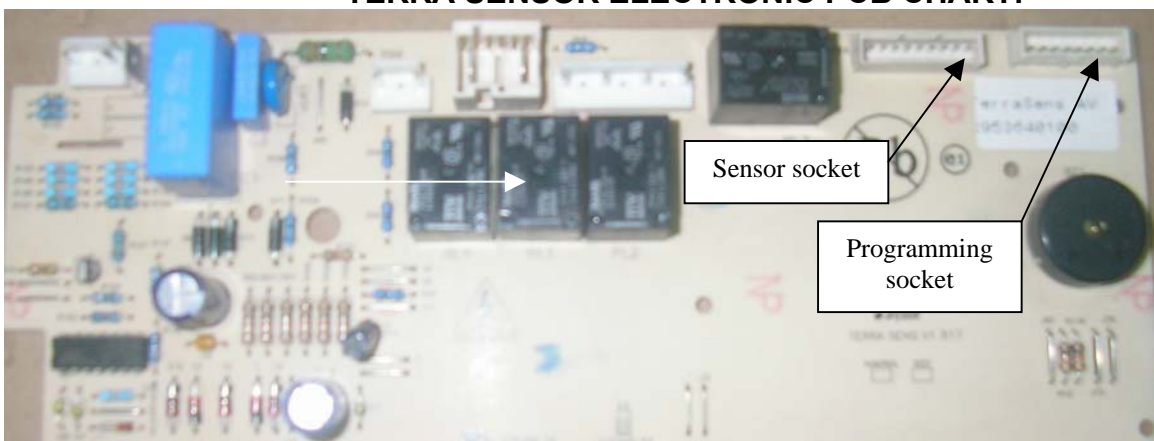

Main motor:

The main motor is two pole Asynchronous motor which runs approx. 2750 rpm. and is equipped by run 8 mF capacitor. motor. It is controlled by a electronic card. Also the motor reverse directions are adjusted by the relay. It has some pulley/belt reduction mechanism, which decrease of the speed 3 times.

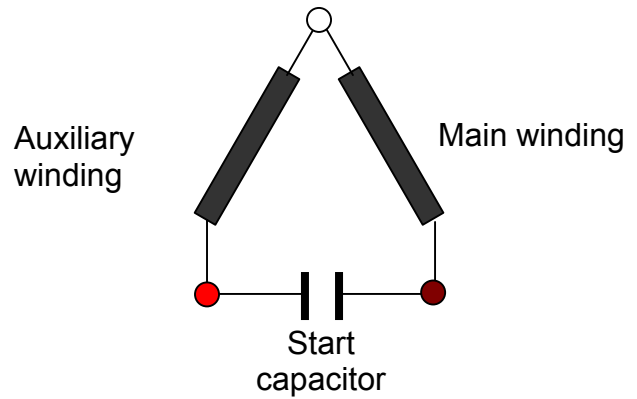
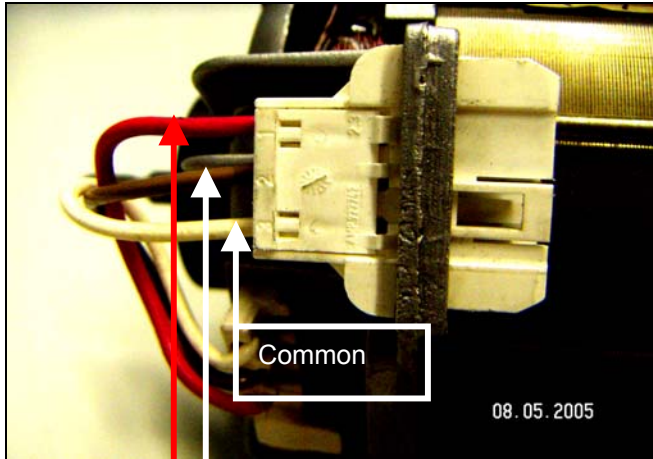

Auxiliary winding

Main winding

Pump Motor (Condenser model only) :

It is a shaded pole Asynchronous motor. The electronic card controls the pump via relay.



Overflow Micro switch (Condenser model only) :

When the water container tank is full, then water overflow through a hose to the pump area. There is a float, when the water comes there it activates the overflow switch, which is paused the program, Tank full LED is illuminated and when selected a buzzer sounds; empty the water and press the start button in order to continue the drying processes.

5 Dryer Programme Tables:

5.1 Terra Vented 866A0 / Timed Base Dryers Programme Steps:						
Programme	Steps	Steps No:	Motor Profiles	Heater	Duration (sn)	Total Duration (sn)
120 min	Heating 1	P1	MH5	User selection	3600	10500
	Heating 2	P2	MH3	User selection	6600	
	Airing	P3	MH2	ISO	300	
	Anti-Creasing	P4	MH4	ISO	0	
100 min	Heating 1	P1	MH5	User selection	90	5400
	Heating 2	P2	MH3	User selection	5010	
	Airing	P3	MH2	ISO	300	
	Anti-Creasing	P4	MH4	ISO	0	
80 min	Heating 1	P1	MH5	User selection	90	4200
	Heating 2	P2	MH3	User selection	3810	
	Airing	P3	MH2	ISO	300	
	Anti-Creasing	P4	MH4	ISO	0	
60 min	Heating 1	P1	MH5	User selection	90	3600
	Heating 2	P2	MH3	User selection	3210	
	Airing	P3	MH2	ISO	300	
	Anti-Creasing	P4	MH4	ISO	0	
40 min	Heating 1	P1	MH5	User selection	0	2700
	Heating 2	P2	MH3	User selection	2400	
	Airing	P3	MH2	ISO	300	
	Anti-Creasing	P4	MH4	ISO	0	
20 min	Heating 1	P1	MH5	User selection	0	1800
	Heating 2	P2	MH3	User selection	1500	
	Airing	P3	MH2	ISO	300	
	Anti-Creasing	P4	MH4	ISO	0	
10 min	Heating 1	P1	MH5	User selection	0	600
	Heating 2	P2	MH3	User selection	300	
	Airing	P3	MH2	ISO	300	
	Anti-Creasing	P4	MH4	ISO	0	
Airing	Heating 1	P1	MH5	ISO	0	600
	Heating 2	P2	MH3	ISO	300	
	Airing	P3	MH2	ISO	300	
	Anti-Creasing	P4	MH4	ISO	0	

HEATING PROFILE :	
ISO	NO HEATING
ISL	1400 W HEATING
ISH	2000 W HEATING

Motor running durations (sn)				
Clockwise / Anti-clockwise	_CW	_MOff	_ACW	_MOff
//MH2	100	2	5	2
//MH3	180	2	5	2
//MH4	4	60	4	60
//MH5	600	0	0	0

5.2 Terra VENTED (876A1) dryer with Sensor Program Steps :								
Programmes	Steps	Time Limits		Humidity Control	Motor Profile	Heater Levels	Drum Temperature limits	Total Durations (minutes)
		Duration Code	Step Duration (min)					
Cotton Extra Dry								
0. Step	Heating1 phase	S11	75	Hum_6	MH3	ISH	65°C	140
1. Step	Heating2 phase	S10	60	Hum_m3	MH3	ISH		
2. Step	Airing phase	S3	5	Hum-No	MH2	IS0		
3. Step	Anti-Creasing phase	S2	120		MH4	IS0		
Cotton Cupboard Dry								
0. Step	Heating1 phase	S11	75	Hum_6	MH3	ISH	65°C	120
1. Step	Heating2 phase	S9	40	Hum_0	MH3	ISH		
2. Step	Airing phase	S3	5	Hum-No	MH2	IS0		
3. Step	Anti-Creasing phase	S2	120		MH4	IS0		
Cotton Ready to Iron								
0. Step	Heating phase	S11	75	Hum_12	MH3	ISH	65°C	100
1. Step	Heating2 phase	S6	20	Hum_12	MH3	ISH		
2. Step	Airing phase	S3	5	Hum-No	MH2	IS0		
3. Step	Anti-Creasing phase	S2	120		MH4	IS0		
Delicates / prog4								
0. Step	Heating1 phase	S4	10	Hum_6	MH2	ISL	40°C	30
1. Step	Heating2 phase	S5	15	Hum_0	MH2	ISL		
2. Step	Airing phase	S3	5	Hum-No	MH2	IS0		
3. Step	Anti-Creasing phase	S2	120		MH4	IS0		
Airing / prog 5								
0. Step	Heating1 phase	S1	0	Hum_m3	MH3	ISL	60°C	10
1. Step	Heating2 phase	S3	5	Hum_m3	MH3	ISL		
2. Step	Airing phase	S3	5	Hum-No	MH2	IS0		
3. Step	Anti-Creasing phase	S2	120		MH4	IS0		
Time program 60' / prog 6								
0. Step	Heating1 phase	S8	30	Hum_m3	MH3	ISL	65°C	60
1. Step	Heating2 phase	S7	25	Hum_m3	MH3	ISL		
2. Step	Airing phase	S3	5	Hum-No	MH2	IS0		
3. Step	Anti-Creasing phase	S2	120		MH4	IS0		
Time program 40' / prog 7								
0. Step	Heating1 phase	S6	20	Hum_m3	MH3	ISL	65°C	40
1. Step	Heating2 phase	S5	15	Hum_m3	MH3	ISL		
2. Step	Airing phase	S3	5	Hum-No	MH2	IS0		
3. Step	Anti-Creasing phase	S2	120		MH4	IS0		
Time program 20' / prog 8								
0. Step	Heating1 phase	S4	10	Hum_m3	MH3	ISL	65°C	20
1. Step	Heating2 phase	S3	5	Hum_m3	MH3	ISL		
2. Step	Airing phase	S3	5	Hum-No	MH2	IS0		
3. Step	Anti-Creasing phase	S2	120		MH4	IS0		
Time program 10' / prog 9								
0. Step	Heating1 phase	S1	0	Hum_m3	MH3	ISL	65°C	10
1. Step	Heating2 phase	S3	5	Hum_m3	MH3	ISL		
2. Step	Airing phase	S3	5	Hum-No	MH2	IS0		
3. Step	Anti-Creasing phase	S2	120		MH4	IS0		
Synthetic Ready to Iron / prog 10								
0. Step	Heating1 phase	S10	60	Hum_12	MH3	ISH	60°C	95
1. Step	Heating2 phase	S8	30	Hum_12	MH3	ISL		
2. Step	Airing phase	S3	5	Hum-No	MH2	IS0		
3. Step	Anti-Creasing phase	S2	120		MH4	IS0		
Synthetic Cupboard Dry / prog 11								
0. Step	Heating1 phase	S10	60	Hum_12	MH3	ISH	65°C	105
1. Step	Heating2 phase	S9	40	Hum_6	MH3	ISL		
2. Step	Airing phase	S3	5	Hum-No	MH2	IS0		
3. Step	Anti-Creasing phase	S2	120		MH4	IS0		

HEATING PROFILE :

IS0	NO HEATING							
ISL	1400 W HEATING							
ISH	2000 W HEATING							
	*Empty Drum logic , after max 2 minutes Dryer skip the steps and goes to the Airing phase. *Low heat-high heat button and buzzer cancel are optional. (depend on the models) . *Anti-Creasing mode duration is 2 hour's.							
	Drying	Ready to Iron	Cupboard Dry	Airing / End	Start	Auxiliary function	Filter	Tank
Drying	+	-	-	-	+	+/-	-	-
Ready to Iron	-	+	-	-	+	+/-	-	-
Cupboard Dry	-	-	+	-	+	+/-	-	-
Airing	-	-	-	+	+	+/-	-	-
End	-	-	-	X	-	+/-	-	-
Filter Blocked	According to the Program Step related leds are on.				+	+/-	+	-
Tank Full	According to the Program Step related leds are on.				X	+/-	-	+

Drum movement Step Durations (sn)				
Movement directions	_CW	_MOff	_ACW	_MOff
//MH2	100	2	5	2
//MH3	180	2	5	2
//MH4	4	60	4	60

5.3 TERRA 866C01 TYPE (BASE) TIMED CONDENSER PROGRAMME TABLE

Program	Phase	Motor Profile	Heater Profile	Time(sec)	Total Time (min)
140 min	Heating 1	P1	MH5	User Selection	0
	Heating 2	P2	MH3	User Selection	8400
	Airing	P3	MH4	IS0	300
	Anti-Crease	P4	MH2	IS0	7200
130 min	Heating 1	P1	MH5	User Selection	0
	Heating 2	P2	MH3	User Selection	7800
	Airing	P3	MH4	IS0	300
	Anti-Crease	P4	MH2	IS0	0
100 min	Heating 1	P1	MH5	User Selection	0
	Heating 2	P2	MH3	User Selection	5700
	Airing	P3	MH4	IS0	300
	Anti-Crease	P4	MH2	IS0	7200
80 min	Heating 1	P1	MH5	User Selection	0
	Heating 2	P2	MH3	User Selection	4500
	Airing	P3	MH4	IS0	300
	Anti-Crease	P4	MH2	IS0	7200
60 min	Heating 1	P1	MH5	User Selection	0
	Heating 2	P2	MH3	User Selection	3300
	Airing	P3	MH4	IS0	300
	Anti-Crease	P4	MH2	IS0	7200
30 min	Heating 1	P1	MH5	User Selection	0
	Heating 2	P2	MH3	User Selection	1500
	Airing	P3	MH4	IS0	300
	Anti-Crease	P4	MH2	IS0	7200
10 min	Heating 1	P1	MH5	User Selection	0

	Heating 2	P2	MH3	User Selection	300	
	Airing	P3	MH4	ISO	300	
	Anti-Crease	P4	MH2	ISO	7200	
Airing	Heating 1	P1	MH5	ISO	0	10
	Heating 2	P2	MH3	ISO	300	
	Airing	P3	MH4	ISO	300	
	Anti-Crease	P4	MH2	ISO	7200	
ISO : Heater Off "User Selection" is set by Heater High/Low Auxiliary Button						

5.4 Terra Condenser Sensor Dryer 876C11/876C 12 (TankUp)

Heating Profile : IS0NO HEATER ISL 1400 W HEATER ISH2000 W HEATER

5.4...Terra Condenser Sensor Dryer 876C11&12 Programme Table

Programme	Phase	Phase time code	Phase duration	Humidity Conditions	Motor Profile	Motor Profile	Total Time (min)
Cottons Extra Dry							
0. Step	Heating1 fazı	S12	85	Nem_6	MH3	High	150
1. Step	Heating2 fazı	S10	60	Nem_m3	MH3	High	
2. Step	Airing phase	S3	5	N/A	MH3	Off	
3. Step	Anti-Creasing phase	S2	120		MH4	Off	
Cottons Ready to Wear							
0. Step	Heating1 fazı	S11	75	Nem_6	MH3	High	145
1. Step	Heating2 fazı	S13	65	Nem_0	MH3	High	
2. Step	Airing phase	S3	5	N/A	MH2	Off	
3. Step	Anti-Creasing phase	S2	120		MH4	Off	
Cottons Ready to Iron							
0. Step	Heating1 fazı	S11	75	Nem_12	MH3	High	110
1. Step	Heating2 fazı	S8	30	Nem_12	MH3	High	
2. Step	Airing phase	S3	5	N/A	MH2	Off	
3. Step	Anti-Creasing phase	S2	120		MH4	Off	
Delicate / prog4							
0. Step	Heating1 fazı	S4	10	Nem_6	MH2	Low	40
1. Step	Heating2 fazı	S7	25	Nem_0	MH2	Low	
2. Step	Airing phase	S3	5	N/A	MH2	Off	
3. Step	Anti-Creasing phase	S2	120		MH4	Off	
Airing / prog 5							
0. Step	Heating1 fazı	S1	0	Nem_m3	MH3	Low	10
1. Step	Heating2 fazı	S3	5	Nem_m3	MH3	Low	
2. Step	Airing phase	S3	5	N/A	MH2	Off	
3. Step	Anti-Creasing phase	S2	120		MH4	Off	
Time programmes 60' / prog 6							
0. Step	Heating1 fazı	S8	30	Nem_m3	MH3	Low	60
1. Step	Heating2 fazı	S7	25	Nem_m3	MH3	Low	
2. Step	Airing phase	S3	5	N/A	MH2	Off	
3. Step	Anti-Creasing phase	S2	120		MH4	Off	

Time programmes 40' / prog 7							40
0. Step	Heating1 fazı	S6	20	Nem_m3	MH3	Low	
1. Step	Heating2 fazı	S5	15	Nem_m3	MH3	Low	
2. Step	Airing phase	S3	5	N/A	MH2	Off	
3. Step	Anti-Creasing phase	S2	120		MH4	Off	
Time programmes 20' / prog 8							20
0. Step	Heating1 fazı	S4	10	Nem_m3	MH3	Low	
1. Step	Heating2 fazı	S3	5	Nem_m3	MH3	Low	
2. Step	Airing phase	S3	5	N/A	MH2	Off	
3. Step	Anti-Creasing phase	S2	120		MH4	Off	
Time programmes 10' / prog 19							10
0. Step	Heating1 fazı	S1	0	Nem_m3	MH3	Low	
1. Step	Heating2 fazı	S3	5	Nem_m3	MH3	Low	
2. Step	Airing phase	S3	5	N/A	MH2	Off	
3. Step	Anti-Creasing phase	S2	120		MH4	Off	
Synthetics Ready to Iron / prog 10							120
0. Step	Heating1 fazı	S11	75	Nem_12	MH3	High	
1. Step	Heating2 fazı	S9	40	Nem_12	MH3	Low	
2. Step	Airing phase	S3	5	N/A	MH2	Off	
3. Step	Anti-Creasing phase	S2	120		MH4	Off	
Synthetics Ready to Wear / prog 11							120
0. Step	Heating1 fazı	S11	75	Nem_12	MH3	High	
1. Step	Heating2 fazı	S9	40	Nem_6	MH3	Low	
2. Step	Airing phase	S3	5	N/A	MH2	Off	
3. Step	Anti-Creasing phase	S2	120		MH4	Off	

6 Door reverseability

1. Unplug the dryer.
2. Open the door.
3. Turn the contact pin in the upper part of door by 90° into the anti-clockwise direction and remove it.

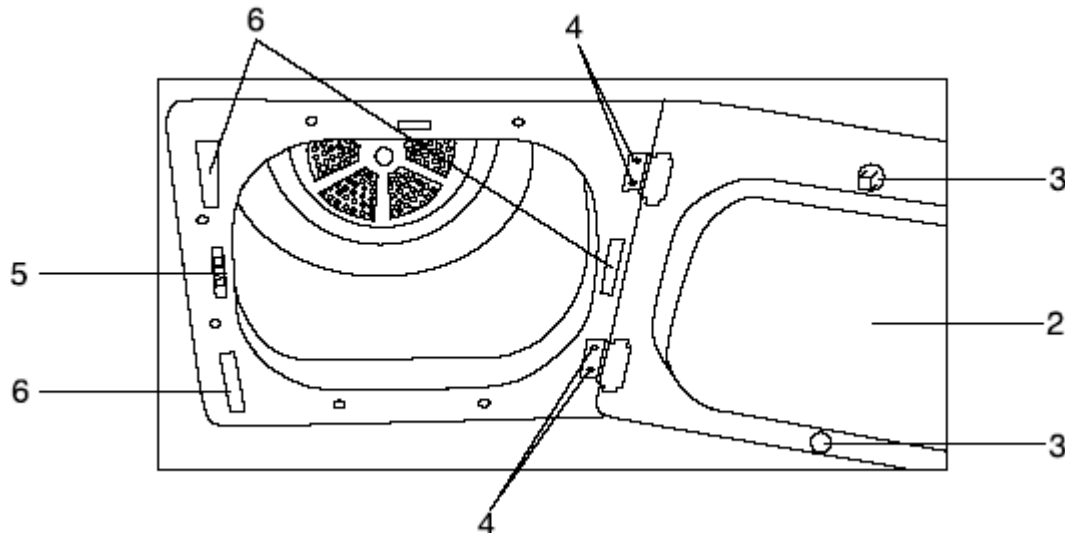

4. Unscrew the 2 screws of each door hinge and remove the door.
5. Removing the door lock: Using a flat screwdrivers release the snap-fitted door lock.
6. Remove 2 blind cover for the hinges and one for the door-lock on the opposite side.
7. Reverse the door: Fasten the door on the desired side with 4 screws. Fix the contact pin into the top side of the door by turning 90° into the clockwise direction.
8. Insert the door lock system on the opposite side of the hinge fixation and be sure it is snap-fitted.