

(ART NO. WR18170 C6)

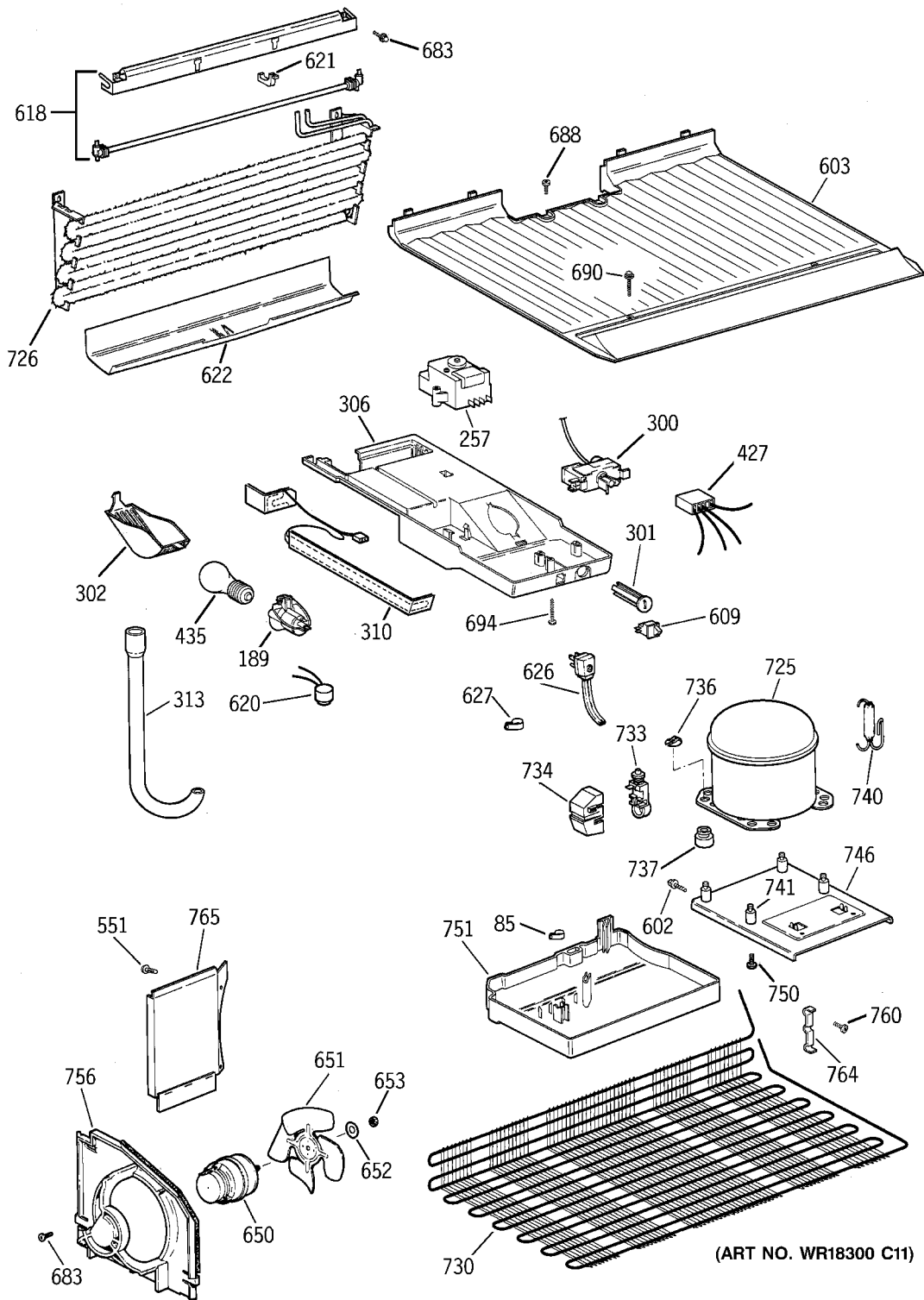

(ART NO. WR18300 C11)