

(ART NO. WR18271 C3)

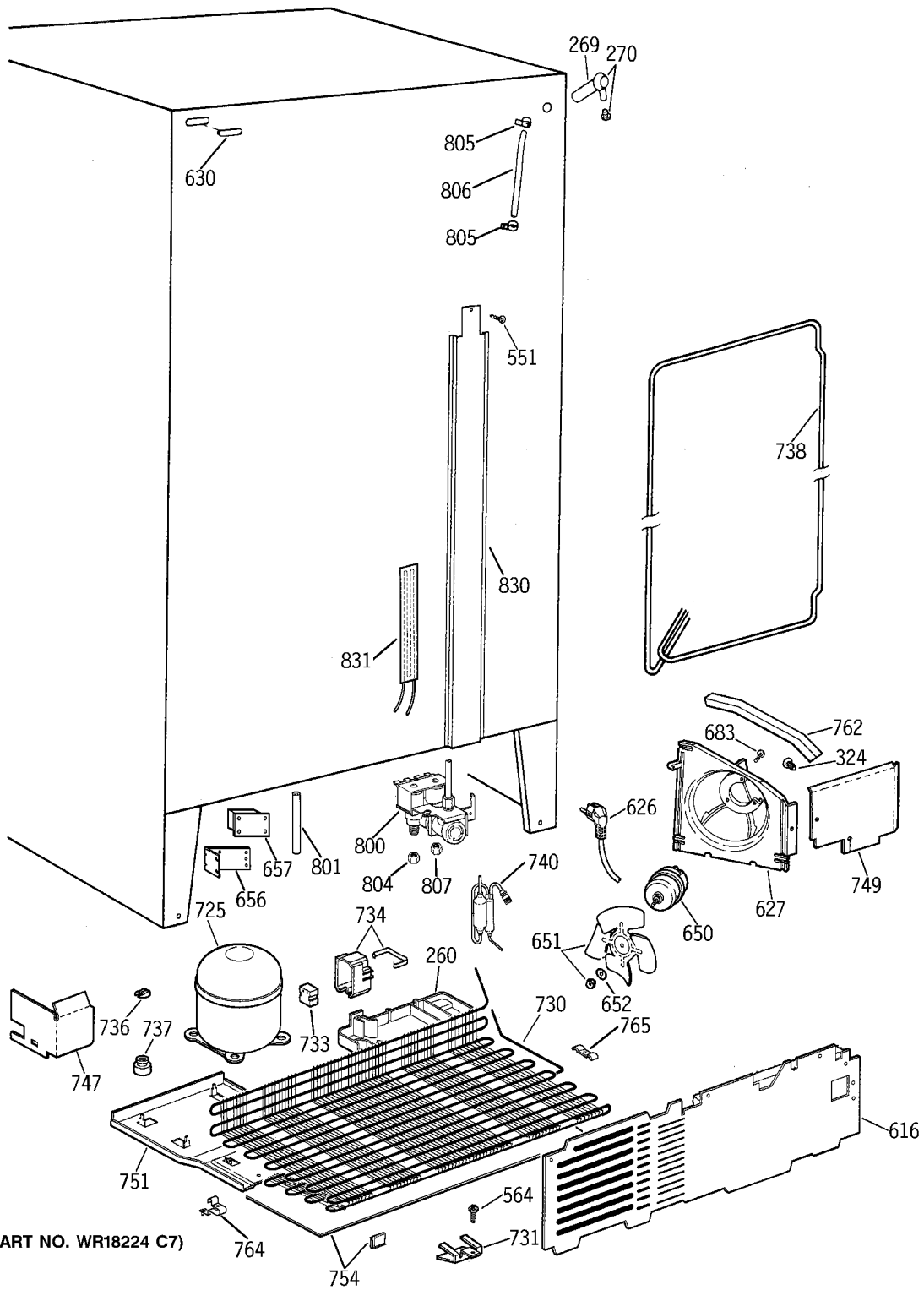

(ART NO. WR18224 C7)