

# Table of Contents

---

Regulatory Information .....	3
Description of Warning Symbols .....	3
Safety Notices .....	4
Preface .....	6
Warranty and Service .....	6
1. Getting Started .....	8
1.1 Package Contents .....	8
1.2 Introducing the TV .....	9
1.3 Features .....	9
1.4 Control Panel .....	10
1.5 Input and Output Jacks .....	10
1.6 Remote Control .....	12
1.7 Inserting the Remote Control Batteries .....	16
2. Setting up your TV .....	18
2.1 Power Connection .....	18
2.2 Rear Connections .....	18
2.3 Using the TV .....	20
2.3.1 Turning the TV On and Off .....	20
2.3.2 Switching Source Signals .....	20
2.3.3 Performing an Automatic Channel Search .....	20
2.3.4 Selecting Channels .....	20
2.3.5 Adjusting the Volume .....	20
3. Adjusting On-Screen Display (OSD) Settings .....	21
3.1 OSD Setting Menus .....	22
3.2 Adjusting Picture Settings .....	22
3.3 Adjusting Sound Settings .....	23
3.4 Adjusting TV Settings .....	24
3.5 Adjusting Features Settings .....	27
3.6 Adjusting Parental Settings .....	29

# Table of Contents

---

4. Troubleshooting .....	30
5. Support Timing .....	31
6. Specifications .....	32
7. Disassembling the stand base .....	33
8. Using the Cable Organizer .....	34

## Regulatory Information

### CE Conformity Statement

This device is in conformity with the requirements of EU Council Directive 2004/108/EC on the approximation of the laws of the Member States relating to electromagnetic compatibility and Directive 2006/95/EC on the harmonization of the laws of Member States relating to electrical equipment for use within certain voltage limits. Hannspree cannot accept responsibility for any failure to satisfy the requirements resulting from a non-recommended modification of the device.

### Description of Warning Symbols

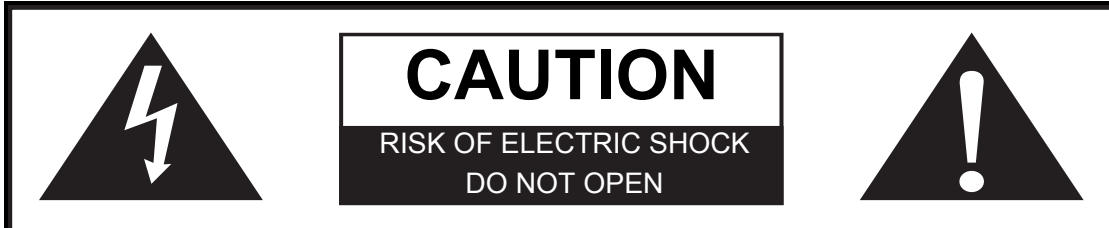

#### WARNING



This symbol is used to alert users to pay attention to important descriptions regarding usage, maintenance (repair), and additional important information related to this TV.

#### CAUTION



This symbol is used to alert users to the risk of electric shocks due to dangerous and uninsulated components.

## Safety Notices



### Installation Safety Notes

#### Location

Avoid allowing the TV to get prolonged exposure to sunlight or other strong sources of heat. Leave sufficient distance between the TV and the wall to provide enough space for the emission of heat.



### WARNING

To reduce the risk of fire or electric shock, do not expose this apparatus to rain or moisture.

Apparatus shall not be exposed to dripping or splashing and no objects filled with liquids, such as vases, shall be placed on the apparatus.



### CAUTION

These servicing instructions are for use by qualified service personnel only. To reduce the risk of electric shock, do not perform any servicing other than that contained in the operating instructions unless you are qualified to do so.



### WARNING

To prevent the spread of fire, keep candles or other open flames away from this product at all times.

---

## Notes:

- **The LCD TV is for entertainment use only and visual display tasks are excluded.**
- **This device uses a VGA connector to connect to a PC. To reduce the influence of main frequency on the source signal, use a VGA monitor cable with ferrite shield.**

## Personal Safety

- 
1. To avoid overloading the power supply, never plug too many electrical devices into an outlet, power strip, or extension cable.

---

  2. Dangerous high-voltage electric power components are located inside the TV. To avoid electric shock, do not disassemble the casing.

---

  3. Do not place or drop metals, small objects, or flammable materials into the vent of the TV.

---

  4. If the TV is dropped, falls down, or is otherwise damaged, unplug the power cord immediately and contact an authorized service technician.

---

  5. If any fluid is sprayed or dropped into the TV, contact an authorized service technician.

---

  6. The screen of the TV is made of glass. Avoid hitting or scraping it. If the screen is broken, do not touch the broken glass.

---

  7. Do not allow children to use the TV unattended.

---

  8. Be careful when disconnecting the power plug. Hold the plug. Do not attempt to disconnect the plug by pulling on the power cord.

---

## Installation

- 
1. Do not place the TV in locations where there is excessive steam or dust.

---

  2. Avoid blocking the TV's vents, do not place the TV on a bed, sofa, carpet, or in a sealed cabinet.

---

  3. Install the outdoor antenna away from power transmission lines to avoid possible danger.

---



## Preface

---

Thank you for purchasing a Hannspree Liquid Crystal Display Television (LCD TV). Your new TV will allow you to enjoy superior audio and video while enriching your lifestyle with advanced technology.

Please carefully read this manual in its entirety before setting up, using or operating your TV. To ensure the safe and correct installation and operations of the TV, it is important that the safety and operation instructions in this manual are followed.

This instruction manual is designed to assist you in setting up and using the TV. The information in this manual has been carefully checked for accuracy; however, no guarantee is given to the correctness of the contents. The information in this manual is subject to change without notice.

To the extent allowed by applicable law, Hannspree, Inc. (“Hannspree”) shall not be liable for direct, indirect, special, exemplary, incidental or consequential damages arising from any defect or omission in this manual, even if advised of the possibility of such damages in advance.



## Warranty and Service

---

For complete warranty service information, please refer to the “Warranty Card” enclosed with your TV.

---

## Copyright

© Copyright 2010 Hannspree, Inc.

All rights reserved. This manual is protected by copyright and distributed under licenses restricting its use, copying and distribution. No part of this manual may be reproduced in any form by any means without the prior written authorization of Hannspree. The TV described in this manual may include copyrighted software of Hannspree (or other third parties). Hannspree (or other third parties) preserves the exclusive rights for copyrighted software, such as the right to distribute or reproduce the copyrighted software. Accordingly, and to the extent allowed by applicable law, any copyrighted software contained in the product described herein shall not be distributed, modified, reverse engineered, or reproduced in any manner without the prior written authorization of Hannspree (or of other third parties).

The Hannspree logos presented herein are trademarks of Hannspree. All other product names, trademarks or logos mentioned herein are used for identification purpose only, and may be the trademarks or registered trademarks of their respective owners.

The purchase of the product described herein shall not be deemed to grant, either directly or by implication, estoppel or otherwise, any license under the copyrights, patents, patent applications or trademarks of Hannspree, except for the normal, non-exclusive use that arises by operation of law in the sale of a product.

## Trademark Notice



Hannspree products incorporate High-Definition Multimedia Interface (HDMI™) technology.

HDMI, the HDMI logo and High-Definition Multimedia Interface are trademarks or registered trademarks of HDMI Licensing LLC.

## License Notice and Trademark Acknowledgment



Manufactured under license from Dolby Laboratories.  
"Dolby" and the double-D symbol are trademarks of Dolby Laboratories.

# Getting Started

---

## 1.1 Package Contents

Make sure the following components are included in the box. Please contact Hannspree Customer Service immediately if anything is missing or damaged.

- TV
- User's manual
- Quick start guide
- Warranty card
- Power cord
- Remote control and batteries
- TV cleaning cloth
- Stand screws x 4 (for 27.5"/31.5"/42")



ME61



According to WEEE regulation, this TV can't be handled as normal trash in Europe when it is out of usage. Please refer to the recycle information from our website to handle it.



---

## 1.2 Introducing the TV

You can watch SECAM/ PAL/ DVB-T broadcast, cable, or digital television channels, and easily connect a VCR, STB or DVD player to the SCART, HDTV (Component), AV (Composite), and HDMI input ports (location of these ports depends on model). You can also use the TV as a monitor for your PC by connecting it through the VGA port.

Convenient control buttons located on the TV and a handy remote control let you change channels, adjust the volume, and change display settings through an easy-to-use on-screen display menu system. The built-in stereo speakers provide full rich sound and a convenient audio output port lets you connect to an external audio system or earphones.

## 1.3 Features

- TV Tuner: Built-in TV Tuner
- Audio/ Video support:
  - SCART inputs
  - VGA (PC) input
  - HDMI inputs
  - HDTV (Component) input
  - R/L audio inputs
  - PC line input
  - 3.5 mm stereo earphone output
  - AV (Composite) input
  - SPDIF output (27.5"/31.5"/42")
  - SPDIF output (digital audio out) (18.5"/21.6"/24.6")
- On-Screen Display (OSD) menu system
- Teletext (TV RF+SCART) 1.5v. with 100 pages memory
- Built-in stereo speakers
- Image Enhancement Technology
  - 3:2/2:2 pull down
  - 3D Comb Filter
  - HD-ready TV
- Noise Reduction
- Advanced 3D de-interlacing
- Edge Enhancement

### Note:









- The supporting devices mentioned in this manual may vary on different models. For more information, please refer to the manufacturer's user manual or the Quick Start Guide of your TV model.



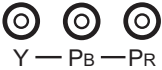

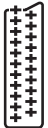
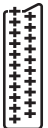

## 1.4 Control Panel

Description	Button	Function
Power		Press to turn the TV on or off.
Input source	<b>INPUT</b>	Press to select the proper input source.
Menu	<b>MENU</b>	Press to turn the on-screen display (OSD) menu on / off.
Program select	<b>P▲</b>	Press to increase the program number or move upward to the previous item on the OSD menu.
Program select	<b>P▼</b>	Press to decrease the program number or move downward to the next item on the OSD menu.
Volume adjust	<b>VOL +</b>	Press to increase the volume or move to the right on the OSD menu.
Volume adjust	<b>VOL -</b>	Press to decrease the volume or move to the left on the OSD menu.
Remote IR sensor		Receive incoming remote control commands.
Power/ Standby indicator		Indicate power or standby status, power on/off represent to Green/Red light indicators.
Speakers		Deliver high-quality sounds.

## 1.5 Input and Output Jacks



Description	Connector	Function
Cable/Antenna	TV/DTV 	Connect to an antenna or cable TV.









Description	Connector	Function
Earphone Output		Connect to earphones or external speakers with built-in amplifier.
Component/ CVBS Inputs (Audio)	L -AUDIO- R 	Connect to an external device, such as a VCR, STB, or a DVD player.
Component Inputs (Video)	 Y — PB — PR	Connect to an external device, such as a VCR, STB, or a DVD player.
PC Audio Input	AUDIO IN 	Connect to a PC's line / audio port.
SCART 1	SCART 1 	Connect to an external device, such as a VCR, STB, or a DVD player with AV, S-Video, RGB, L/R IN, Analog TV Out, and L/R Out.
SCART 2	 SCART 2	Connect to an external device, such as a VCR, STB, or a DVD player with AV, S-Video, RGB, L/R IN, Analog TV Out, and L/R Out.
VGA (PC) Input	VGA 	Connect to a PC's VGA port.
Service	SERVICE   SERVICE	Service only. Not available for users.
Video	VIDEO 	Connect to an external device, such as a VCR, STB, or a DVD player.





Description	Connector	Function
CI	 CI SLOT	Connect to a CI device.
HDMI 1 Input	 HDMI 1	Connect a HDMI equipment or an HDMI-DVI adapter cable to devices such as a DVD player or set-top box.
HDMI 2 Input	 HDMI 2	Connect a HDMI equipment or an HDMI-DVI adapter cable to devices such as a DVD player or set-top box.
HDMI 3 Input	 HDMI 3	Connect a HDMI equipment or an HDMI-DVI adapter cable to devices such as a DVD player or set-top box.
SPDIF	 SPDIF	Connect to a digital audio output device such as a home theater.
Power Connector	 AC IN	Connect to the included power cord.

## 1.6 Remote Control

Description	Icon	Function
Power		Press to turn the TV on or off.
Input Signal Type	<b>INPUT</b>	Press to select the input signal type selections: TV, DTV, SCART, AV, HDMI 1, HDMI 2, HDTV, and PC.

Description	Icon	Function
Keypad	1 2 3 4 5 6 7 8 9 0	Use to select a program directly. Press 0-9 to enter the program numbers (press 1 and 0 for program 10).
Pro.List	<b>Pro.LIST</b>	Press to display the programs contained.
Last	<b>LAST</b> 	Press to return to the last channel selected.
Information	<b>INFO</b>	1. Press to display current channel/program information. 2. During DTV menu selection, press to display help information about Channel Organizer, Channel Sorting, Channel Grouping, Time and Parental Rating.
Menu	<b>MENU</b>	Press to turn the on-screen display (OSD) menu on / off.
OK	<b>OK</b>	Press to confirm selection.
Arrows		Press up, down, left or right to scroll through the on-screen display menus.
Electronic Program Guide	<b>EPG</b>	Press to display detailed programming information for channels (only for DTV).
Teletext mode	<b>TEXT</b>	Press to active teletext.
Volume adjust	<b>VOL+ / VOL-</b>	Press VOL + to increase audio volume. Press VOL - to decrease audio volume.
Mute	<b>MUTE</b> 	Press to eliminate sound. Press it again or press the volume adjust buttons to restore sound.

Description	Icon	Function
Dual sound	I-II 	Press to change the multi sound selection of the TV channel.
Select program	P▲ / P▼	Press P▲ to increase the program number. Press P▼ to decrease the program number.
Red, Green, Yellow, Blue		Press the colored buttons to perform specific tasks in the OSD menu or teletext mode.
Index	INDEX 	Press to display a table of the available teletext subjects. (Programmable in the teletext mode only)
Mix	MIX 	Press to display the teletext over the program on the screen. (Programmable in the teletext mode only)
Adjust size	SIZE 	Press to adjust screen size. (Programmable in the teletext mode only)
Subtitle	SUBTITLE 	With an ATV source, if teletext mode is activated and the teletext has a subtitle page, press to display the subtitle page. With a DTV source, press to display the subtitle OSD, and select the language.
Hold	HOLD 	Press to inactivate automatic page change which only occurs when more than one teletext page exists. (Programmable in the teletext mode only)
Reveal	REVEAL 	Press to display the hidden information, such as solutions to puzzles. (Programmable in the teletext mode only)
Sound Mode	SOUND 	Press continuously to toggle through all the sound setting: Standard, Music, Movie, Speech, or User.

Description	Icon	Function
Picture Mode	<b>PIC</b> 	Press continuously to toggle through all the picture setting: Vivid, Soft, User, Standard.
Favorite channel	<b>FAV.</b> 	Press to open favorite list menu and press $\wedge$ / $\vee$ to select channels. Press OK to go to the selected channel.
Freeze	<b>FREEZE</b> 	Press to pause a video frame on-screen. (Programmable in the TV source only)
Sleep timer	<b>SLEEP</b> 	Press repeatedly to set the sleep timer (15, 30, 45, 60, 90 or 120 minutes). Cancel the timer by selecting the Sleep Off option.
Aspect ratio	<b>ASPECT</b> 	Press to adjust the width-to-height ratio of the image with aspect ratio: AUTO, Full, Normal, Panorama, Zoom, Subtitle and Wide.

**Note:**

- For best results, use the remote control within a proper distance from the front of the TV. Do not exceed an angle of 30 degrees when pointing at TV.
- The operational distance may be shortened when the signal sensor is directly exposed to strong light.
- Aim the transmitter on the remote control at the signal sensor and ensure that there are no obstacles between them.

## 1.7 Inserting the Remote Control Batteries

- 1 Open the battery compartment cover at the back of the remote control (A).

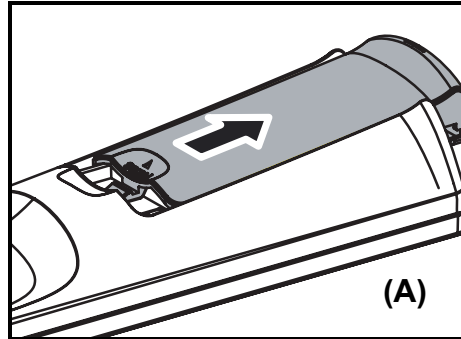

- 2 Insert the batteries paying attention to the polarity markings inside the battery compartment (B).

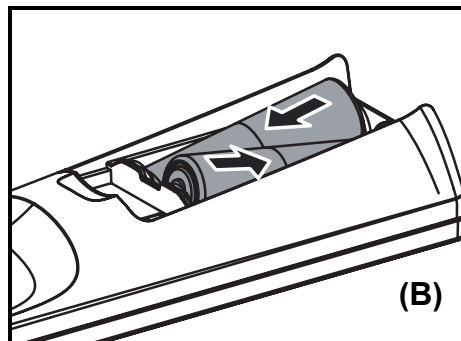

- 3 Replace the battery compartment cover (C).

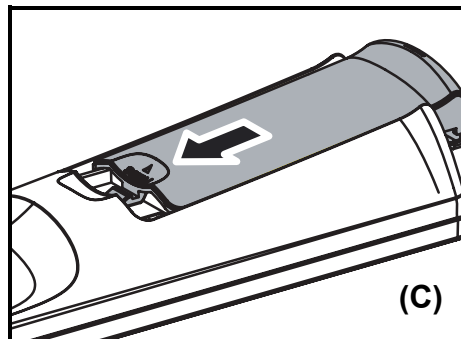





## CAUTION

- If the remote control is not used for a long period, remove the batteries and store them properly.
- Handle damaged or leaking batteries carefully, and wash hands with soap if they come in contact with leaked chemical fluids.
- If your remote control has two batteries, do not mix new and old batteries, or the life of the new batteries will be shortened. Chemical fluids may leak from the old batteries.
- Danger of explosion if battery is incorrectly replaced. Replace only with the same or equivalent type recommended by the equipment manufacturer. Discard used batteries according to manufacturer's instructions.
- Refer to your local recycling or waste disposal rules and contact a local waste disposal vendor to dispose of used batteries.
- The remote control cover may have a magnet in it, so do not place magnetic sensitive items such as watches, credit cards, or flash media close to the cover.
- Do not use force when pulling the remote control cover open; you may damage the hinge.

## Setting up your TV

### 2.1 Power Connection

- 1 Connect the power cord to the AC IN input jack on the rear of the TV.
- 2 Insert the plug at the other end of the power cord into a power outlet.

### 2.2 Rear Connections

See the illustration and table below for device connection instructions.

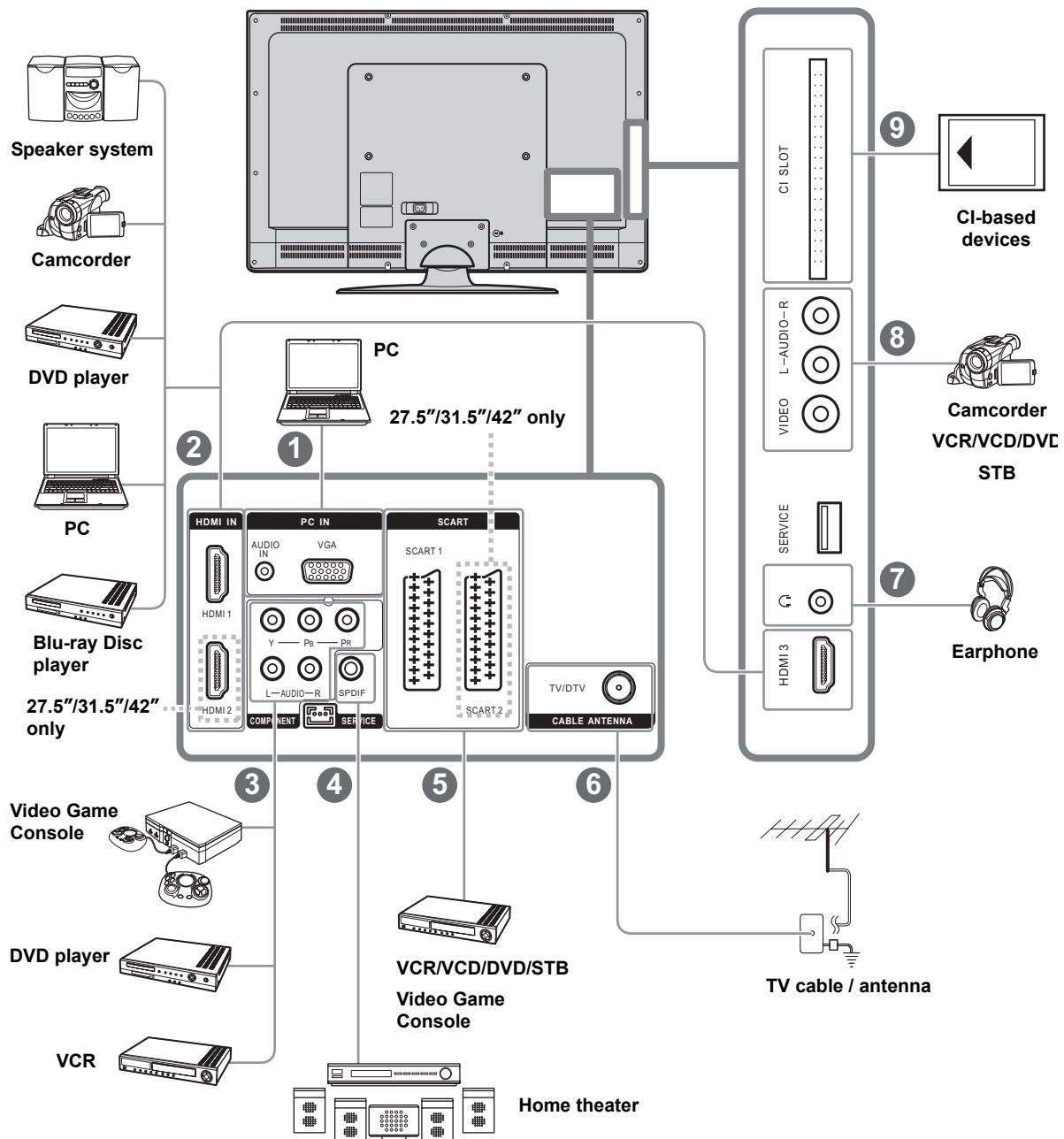



No.	Connector	Notes / Instructions
1	VGA	• The VGA and audio cables are optional.
	AUDIO In	
2	HDMI 1	• The HDMI cable is optional. • When the HDMI to HDMI cable is connected, connecting the audio cable is not necessary. However it's necessary to do so if a HDMI to DVI cable is connected.
	HDMI 2	
	HDMI 3	
3	Component Video Inputs	• The video and audio cables are optional.
	Component Audio Inputs	
4	SPDIF	• The SPDIF cable is optional.
5	SCART 1	• If your AV devices are not equipped with SCART connectors, you will also need a SCART adapter except for a SCART to SCART cable. • When a SCART adapter is used, the S-Video connector and AV connectors cannot be connected at the same time, or the wrong signals might be generated. • The SCART to SCART cable and SCART adapter are optional.
	SCART 2	
6	Cable/Antenna	• If you cannot receive channels after connecting to a TV cable or antenna, try scanning for channels.
7	Earphone	• The internal TV speakers will not output sound when a speaker or earphone is plugged in.
8	Composite Video Input	• The video and audio cables are optional.
	Composite Audio Inputs	
9	CI	• The Common Interface cable is optional.
<b>Note:</b> The available connectors may vary depending on your TV model.		

---

## 2.3 Using the TV

### 2.3.1 Turning the TV On and Off

- 1 Press  on the control panel or remote control. The power LED indicator on the TV changes from red to green, indicating that the TV is on.
- 2 Press  again. The power LED changes from green to red, indicating that the TV is off.

### 2.3.2 Switching Source Signals

Press **INPUT** on the control panel or remote control to select the incoming source signal.

### 2.3.3 Performing an Automatic Channel Search

Before using the TV to view programs, you need to activate the channel search first.

- 1 Press **MENU** on the control panel or remote control, then select to enter the Channel / DTV menu.
- 2 Select Auto Search.
- 3 Press  on the remote control to run the channel search.

### 2.3.4 Selecting Channels

- Press **P▲** on the remote control or control panel to increase the channel number.
- Press **P▼** on the remote control or control panel to decrease the channel number.
- Enter the specific channel number by pressing the number buttons on the remote control.

### 2.3.5 Adjusting the Volume

- 1 Press **VOL+** on the control panel or remote control to increase the volume.
- 2 Press **VOL-** on the control panel or remote control to decrease the volume.
- 3 Press **MUTE** to eliminate sounds, and press **MUTE** again or press the volume buttons to restore the original volume.

# 3

## Adjusting On-Screen Display (OSD) Settings

The On-Screen Display (OSD) menu system provides a quick and simple method to adjust the TV settings. The OSD menu can be accessed conveniently through the buttons on the remote control.

Before going into details of each OSD option, you may get acquainted with the placement of the OSD system:

**MAIN MENU:**  
Displays a list of menus.

**ADJUSTABLE Options:**  
Displays the setting/value of the adjustable options.

**INSTRUCTIONS:**  
Quick instructions for adjusting the settings

Function	TV Control Panel	Remote Control
OSD Menu	MENU	MENU
Up	P▲	Arrow ^
Down	P▼	Arrow v
Select/ Increase	VOL +	Arrow >
Select/ Decrease	VOL -	Arrow <
Return	MENU	MENU

### 3.1 OSD Setting Menus

Follow the instructions indicated on the down side of the OSD Function Menu. Press **P▲/P▼** on the control panel or **^ / v** arrow keys to scroll through the menus, **VOL +** on the control panel or the **>** arrow key to select an item, or **MENU** to exit the OSD menu.

The following menus can be set by different adjustment methods.

### 3.2 Adjusting Picture Settings

- 1 Press **MENU** to enter the OSD Main Menu screen. The **Picture** menu is then displayed.
- 2 Press **>** to enter the **Picture** menu.
- 3 Press **^ / v** to select an item.
- 4 Press **< / >** to adjust the scales or options settings.

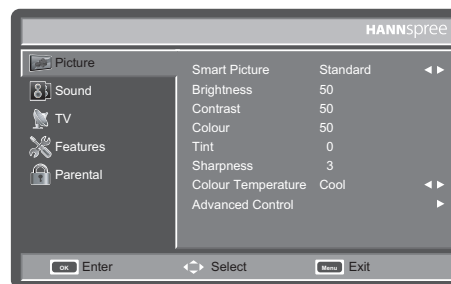

- 5 Press **MENU** to return to the **Picture** menu entry.
- 6 Press **MENU** to exit the OSD menu.
  - The **Picture** menu can be used to adjust the **Smart Picture, Brightness, Contrast, Colour, Tint, Sharpness, Colour Temperature, Advanced Control, and Advanced Video** (PC only) settings.
    - The **Smart Picture** can be set to **Standard, Vivid, Movie, Eco, or Personal**.
    - The **Brightness, Contrast, and Colour** can be adjusted by pressing **< / >** to move the scales from 0 to 100.
    - The **Tint** can be adjusted by pressing **< / >** to move the scales from -32 to 32.
    - The **Sharpness** can be adjusted by pressing **< / >** to move the scales from 0 to 7.
    - The **Colour Temperature** can be set to **Standard, Warm, or Cool**.
    - The **Advanced Control** can be used to adjust the **Noise Reduction, Flesh Tone, Backlight, and X-Contrast**.
    - The **Noise Reduction** can be set to **Auto, Off, Low, Medium, or High**.
    - The **Flesh Tone** can be set to **On or Off**.
    - The **Backlight** can be adjusted by pressing **< / >** to adjust the scales from 0 to 100.
    - The **X-Contrast** can be set to **On or Off**.

- The **Advanced Video** can be used to adjust the **Auto Config, Horizontal, Vertical, Phase, Clock, and Resolution** settings for PC mode.

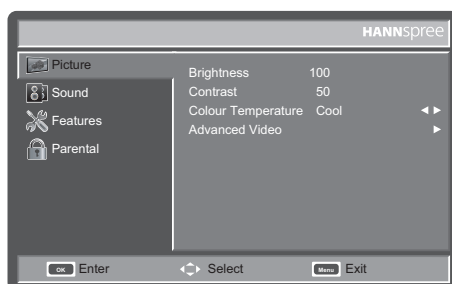

**Note:** The options available on the OSD may vary depending on the input signal source.

### 3.3 Adjusting Sound Settings

- 1 Press **MENU** to enter the OSD Main Menu screen.
- 2 Press **↓** to select the **Sound** menu.
- 3 Press **→** to enter the **Sound** menu.
- 4 Press **↑ / ↓** to select an item.
- 5 Press **← / →** to adjust the scales or options settings.

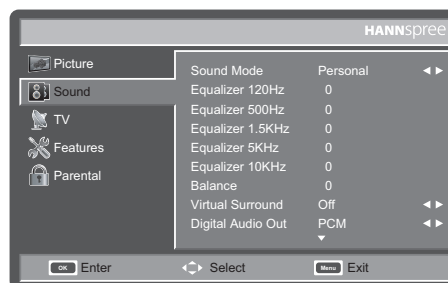

- 6 Press **MENU** to return to the **Sound** menu entry.
- 7 Press **MENU** to exit the OSD menu.

- The **Sound** menu can be used to adjust the **Sound Mode, Equalizer 120Hz, Equalizer 500Hz, Equalizer 1.5KHz, Equalizer 5KHz, Equalizer 10KHz, Balance, Virtual Surround, Digital Audio Out, SPDIF Delay, AVL, Type, and Audio Description** settings.

- The **Sound Mode** can be set to **Music, Speech, or Personal**.
- The **Equalizer 120Hz, Equalizer 500Hz, Equalizer 1.5KHz, Equalizer 5KHz, and Equalizer 10KHz** can be adjusted by pressing **← / →** to move the scales from -6 to 6.
- The **Balance** can be adjusted by pressing **← / →** to move the scales from -50 to 50.
- The **Virtual Surround** can be set to **On** or **Off**.
- The **Digital Audio Out** can be set to **Dolby Digital, PCM, or Off**.

- The **SPDIF Delay** can be adjusted by pressing **< / >** to move the scales from 0 to 250.
- The **AVL** can be set to **On** or **Off**.
- The **Type** can be set to **Normal**, **Hard of Hearing**, or **Audio Description**.
- To adjust the **Audio Description**, select **Audio Description** in the **Type** setting first. Press **< / >** to adjust the scales from 0 to 100.

**Note:** The options available on the OSD may vary depending on the input signal source.

### 3.4 Adjusting TV Settings

- 1 Press **INPUT** and select **TV** as the signal type.
- 2 Press **MENU** to enter the OSD Main Menu screen.
- 3 Press **∨** to select the **TV** menu.
- 4 Press **>** to enter the **TV** menu.
- 5 Press **∧ / ∨** to select an item.
- 6 Press **< / >** to adjust the scales or options settings.
- 7 Press **MENU** to return to the **TV** menu entry.
- 8 Press **MENU** to exit the OSD menu.

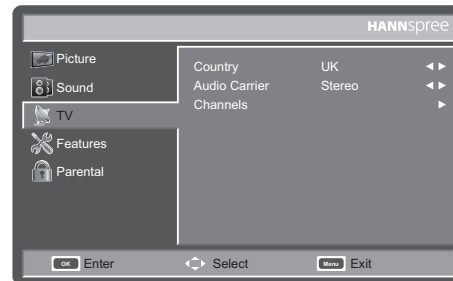

- The **TV** menu can be used to adjust the **Country**, **Audio Carrier**, and **Channels** settings.
  - The **Country** can be set to **Austria, Belgium, Bulgaria, Croatia, Czech Republic, Denmark, Finland, France, Germany, Greece, Hungary, Iceland, Ireland, Italy, Luxembourg, Netherlands, Norway, Poland, Portugal, Romania, Russia, Serbia, Slovakia, Slovenia, Spain, Sweden, Switzerland, Turkey, and UK**.
  - The **Audio Carrier** can be set to **Dual I, Dual II, Mono, and Stereo**.
  - The **Channels** can be used to perform or adjust the **Channel Scan, Update Scan, Single RF Scan, Analog Manual Scan, Channel Skip, Channel Sort, Channel Edit, Decoder, and Analog Ch Fine Tune** settings.



- Select **Channel Scan** to activate the automatic TV channel search.

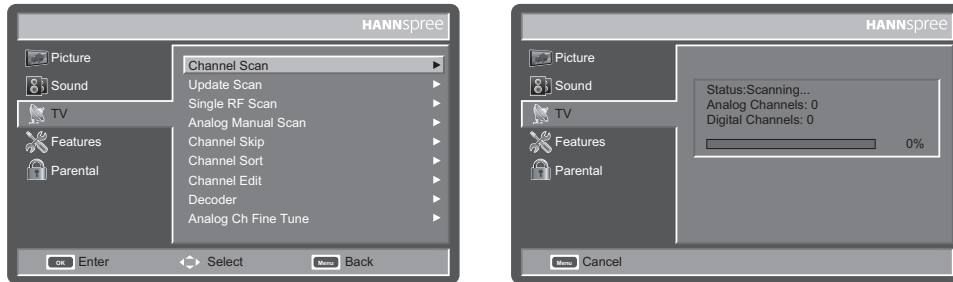

- Select **Update Scan** to automatically add channels to the existing channel list.
- Select **Single RF Scan** to search for digital channels within the selected RF (Radio Frequency) channel.

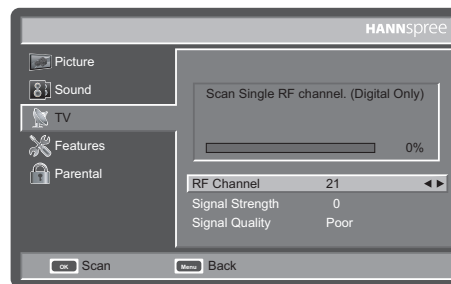

- Select **Analog Manual Scan** to search for analog channels within the specified frequency range.

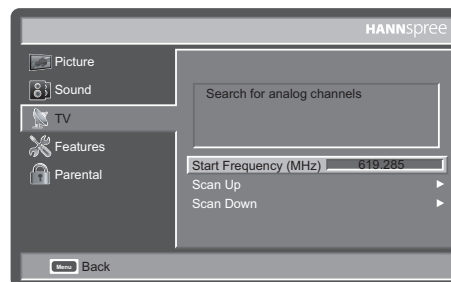

- Use **Channel Skip** to prevent the desired channels from being accessed by pressing **P▲/P▼** on the remote control or control panel.

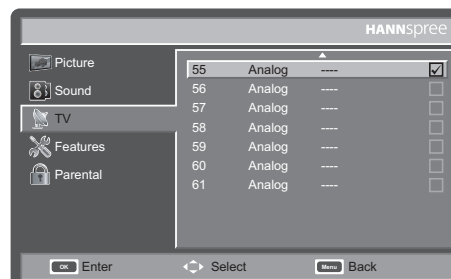

- Select the **Channel Sort** to change the order of the channel list.
- The **Channel Edit** allows you to adjust the detailed items, including **Channel Number**, **Channel Name**, **Frequency**, **Colour System**, and **Sound System** for each channel.

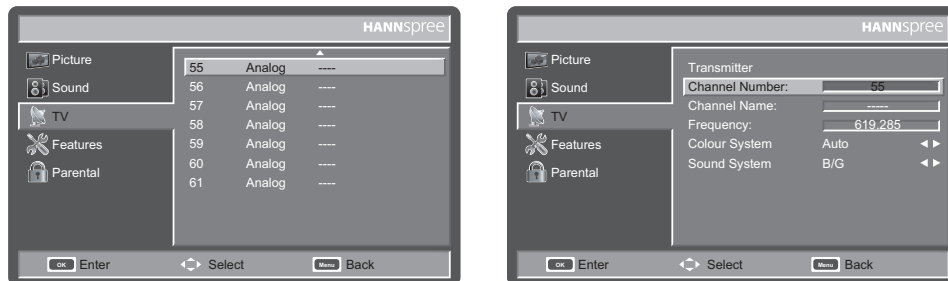

- To change the channel number, select **Channel Number** and use the number keys on the remote control to type numbers.
- To change the channel name, select **Channel Name** and use the number keys on the remote control to type letters, digits, or symbols. Press keys repeatedly to toggle different characters.

KEY	CHARACTER						
0	-	@	0				
1	-	-	1				
2	A	B	C	a	b	c	2
3	D	E	F	d	e	f	3
4	G	H	I	g	h	i	4
5	J	K	L	j	k	l	5
6	M	N	O	m	n	o	6
7	P	Q	R	S	p	q	r s 7
8	T	U	V	t	u	v	8
9	W	X	Y	Z	w	x	y z 9

- To change the channel frequency, select **Frequency** and use the number keys on the remote control to type the desired frequency.
- The **Colour System** can be set to **Auto**, **DAL**, or **SECAM**.
- The **Sound System** can be set to **I**, **D/K**, **A2 D/K**, **A2 D/K1**, **B/G**, **A2 B/G**, **L**, or **L'**.
- The **Decoder** supports the Canal+ (paid TV channel with encrypted programs).
- Select **Analog Ch Fine Tune** to adjust precisely the analog channel frequency to ensure high signal quality.

**Note: The TV Settings are only available in TV mode.**

### 3.5 Adjusting Features Settings

- 1 Press **MENU** to enter the OSD Main Menu screen.
- 2 Press **▼** to select the **Features** menu.
- 3 Press **▶** to enter the **Features** menu.
- 4 Press **▲ / ▼** to select an item.
- 5 Press **◀ / ▶** to change the options settings.
- 6 Press **MENU** to return to the **Features** menu entry.
- 7 Press **MENU** to exit the OSD menu.

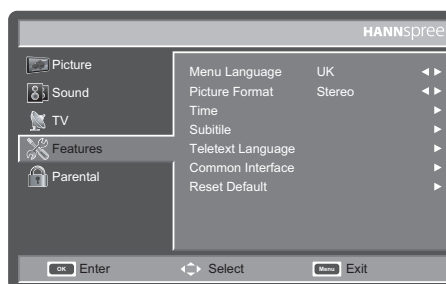

- The **Features** menu can be used to adjust the **Menu Language**, **Picture Format**, **Time**, **Subtitle**, **Teletext Language**, **Common Interface**, **Reset Default**, and **HDMI Scan Info** (HDMI only) settings.
  - The available menu languages are **English**, **Deutsch**, **Français**, **Italiano**, **Español**, **Português**, **Nederlands**, **български**, **Dansk**, **Suomi**, **Svenska**, **Norsk**, **Polski**, **Русский**, **Ceský**, **Hrvatski**, **Magyar**, **Română**, **Slovenský**, **Slovenščina**, **Srpski**, **Türkçe**, and **Ελληνικά**, and **Українська**.
  - The **Time** can be used to adjust the **Time Zone**, **Time**, and **Sleep Timer** settings.
  - The **Subtitle** can be used to adjust the **Analog Subtitle**, **1st Subtitle**, **2nd Subtitle**, and **Subtitle Type** settings.
  - The **Teletext Language** can be used to adjust the **Digital Teletext Lang.** and **Decode Page Lang.** settings.
  - Select **Common Interface** to view the CI supplier information.
  - Select **Reset Default** to restore all settings to the defaults.
  - The **HDMI Scan Info** can be used to adjust the **Automatic**, **Underscan**, and **Overscan** settings.

- The **Picture Format** selections include **Auto**, **Normal**, **Zoom1**, **Zoom2**, **Full**, **Subtitle**, **Native**, and **Wide**. Please see below for details.

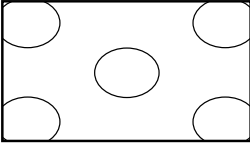
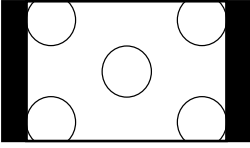
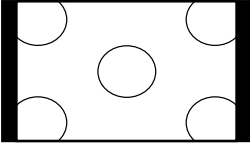
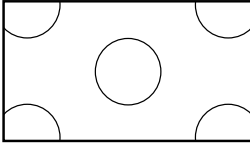
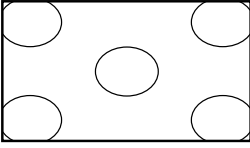
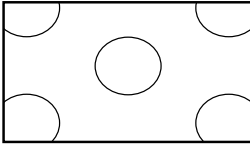
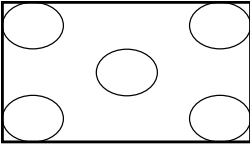
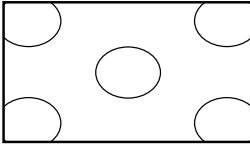
<b>Auto</b>	
<b>Normal</b>	
<b>Zoom1</b>	
<b>Zoom2</b>	
<b>Full</b>	
<b>Subtitle</b>	
<b>Native</b>	
<b>Wide</b>	

**Note:** The options available on the OSD may vary depending on the input signal source.

### 3.6 Adjusting Parental Settings

- 1 Press **INPUT** and select **TV** as the signal type.
- 2 Press **MENU** to enter the OSD Main Menu screen.
- 3 Press **▼** to select the **Parental** menu.
- 4 Press **▶** to enter the **Parental** menu.
- 5 Type the password. The default is 0000.
- 6 Press **▲ / ▼** to select an item.
- 7 Press **◀ / ▶** to adjust the options settings.
- 8 Press **MENU** to return to the **Parental** menu entry.
- 9 Press **MENU** to exit the OSD menu.

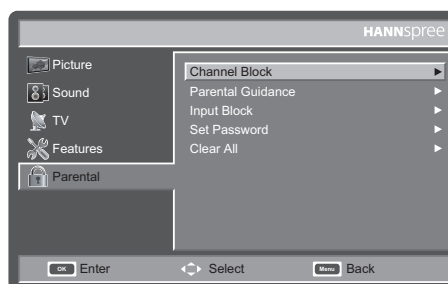

- The **Parental** menu can be used to adjust the **Channel Block**, **Parental Guidance**, **Input Block**, **Set Password**, and **Clear All** settings.
  - Select **Channel Block** to block desired channels.
  - Select **Parental Guidance** to set Age Rating. Press **◀ / ▶** to adjust the value from 4 to 18 or to set as **None**.
  - Select **Input Block** to block desired input sources.
  - Select **Set Password** to change the password.

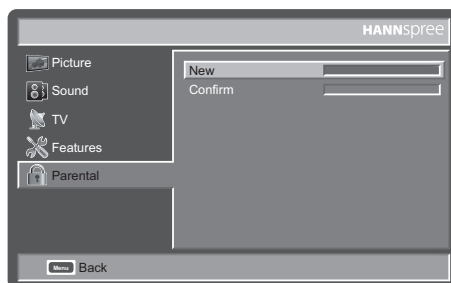

- Select **Clear All** to restore defaults for all parental settings.

**Note: The Channel Block is only accessible in TV mode.**

## Troubleshooting

Situation	Solution
No picture and sound.	<ul style="list-style-type: none"> <li>• Connect the power cord properly.</li> <li>• Check if the power LED is on or not.</li> <li>• Press  on the control panel or remote control.</li> <li>• Press Input to cycle through connected video sources.</li> <li>• Press <b>P▲</b> or <b>P▼</b> to switch to other TV programs.</li> <li>• Make sure all cables are connected properly.</li> </ul>
No picture, or poor picture, sound is OK.	<ul style="list-style-type: none"> <li>• Check the antenna and cable connections.</li> <li>• Adjust the brightness in the <b>Picture</b> OSD menu.</li> </ul>
Picture is not in color.	<ul style="list-style-type: none"> <li>• Adjust the <b>colour</b> option in the <b>Picture</b> OSD menu.</li> </ul>
Picture is OK, no sound.	<ul style="list-style-type: none"> <li>• Make sure the source device is functioning properly.</li> <li>• Make sure the audio cable is connected securely.</li> <li>• Turn the mute off.</li> <li>• Press <b>VOL +</b> on the control panel or remote control.</li> </ul>
One of the speakers has no sound.	<ul style="list-style-type: none"> <li>• Adjust the <b>balance</b> in the <b>Sound</b> OSD menu.</li> </ul>
Cannot receive some TV channels using cable TV.	<ul style="list-style-type: none"> <li>• Try the <b>Auto Search</b> function in the <b>Channel</b> or <b>DTV</b> OSD menu.</li> </ul>
Want to reset TV settings.	<ul style="list-style-type: none"> <li>• Use the <b>Reset</b> function in the <b>Setup</b> OSD menu.</li> </ul>
Cannot operate menus.	<ul style="list-style-type: none"> <li>• If OSD items are colored in gray, the system is in a state such that those settings are not available.</li> </ul>
Screen image turns over.	<ul style="list-style-type: none"> <li>• Make sure the video signal cable is connected properly.</li> </ul>
Snow appears on the screen.	<ul style="list-style-type: none"> <li>• Adjust the location of the antenna, placing it far from roads or sources of interference.</li> <li>• Check the antenna and the video signal line connections.</li> </ul>
Blurred or overlapped images.	<ul style="list-style-type: none"> <li>• Adjust the sharpness setting.</li> <li>• Choose programs with high quality signals.</li> <li>• Adjust the direction of the antenna or replace the video signal cable.</li> </ul>
Remote control doesn't work.	<ul style="list-style-type: none"> <li>• Make sure the battery is inserted correctly.</li> <li>• Replace the battery with a new one.</li> <li>• Make sure the TV power cord is plugged in.</li> <li>• Make sure the path between the remote control and the sensor is clear.</li> <li>• Try operating the remote control at a closer distance to the TV.</li> </ul>

## PC Mode Support Timing

Mode	Resolution	Horizontal Freq. (KHz)	Vertical Freq. (Hz)	Pixel Clock (MHz)	SJ19DMAB SJ22DMAB	SJ25DMAB SJ28DMBB SJ32DMBB SJ42DMBB
1	640 x 480	31.469	59.94	25.175	V	V
2	640 x 480	37.861	72.809	31.5	V	V
3	640 x 480	37.5	75	31.5	V	V
4	720 x 400	31.469	70.087	28.322	V	V
5	800 x 600	35.156	56.25	36	V	V
6	800 x 600	37.879	60.317	40	V	V
7	800 x 600	48.077	72.188	50	V	V
8	800 x 600	46.875	75	49.5	V	V
9	1024 x 768	48.363	60.004	65	V	V
10	1024 x 768	56.476	70.069	75	V	V
11	1024 x 768	60.023	75.029	78.75	V	V
12	1280 x 720	44.772	59.855	74.25	V	V
13	1280 x 768	47.776	59.87	79.5	V	V
14	1360 x 768	47.712	60.015	85.5	V	
15	1280 x 1024	63.981	60.02	108	V	V
16	1440 x 900	55.935	59.887	106.5		V
17	1680 x 1050	65.29	59.954	146.25		V
18	1920 x 1080	66.587	59.934	138.5		V
19	1920 x 1200	66.587	59.934	138.5		V (SJ28DMBB)

## Video Mode Support Timing

Resolution (active dot)	HDMI/YPbPr
480i	V
576i	V
480p	V
576p	V
720p	V
1080i	V
1080p (SJ25DMAB, SJ28DMBB, SJ32DMBB, SJ42DMBB only)	V

## Specifications

Model No.	SJ19DMAB	SJ22DMAB	SJ25DMAB	SJ28DMBB	SJ32DMBB	SJ42DMBB
<b>DISPLAY</b>						
<b>Aspect Ratio</b>	16:9	16:9	16:9	16:10	16:9	16:9
<b>Resolution</b>	1366 x 768	1366 x 768	1920 x 1080	1920 x 1200	1920 x 1080	1920 x 1080
<b>OSD Language</b>	Bulgarian, Croatian, Czech, Danish, Dutch, English, Finnish, French, Ukrainian, German, Greek, Hungarian, Italian, Norwegian, Polish, Portuguese, Romanian, Russian, Serbian, Slovak, Slovenian, Spanish, Swedish, Turkish					
<b>ENHANCEMENT</b>						
<b>Sound Output (RMS Watts)</b>	3 W	3 W	5 W	10 W	10 W	10 W
<b>Sound Mode</b>	Personal, Music, Speech					
<b>Picture Format</b>	Auto, Normal, Zoom1, Zoom2, Full, Subtitle, Wide (70cm/27.5" only), Native (HDMI only)					
<b>Picture Mode</b>	Standard, Vivid, Movie, Eco, Personal					
<b>CONNECTION</b>						
<b>Rear Connector</b>	Tuner Input (75 Ω) PC IN: D-SUB and PC Audio Component Video and L/R Audio Input					
	SCART 1 SPDIF Output (Digital audio out) HDMI 1	SCART 1 SPDIF Output (Digital audio out) HDMI 1	SCART 1 SPDIF HDMI 1	SCART 1 SCART 2 SPDIF HDMI 1 HDMI 2	SCART 1 SCART 2 SPDIF HDMI 1 HDMI 2	SCART 1 SCART 2 SPDIF HDMI 1 HDMI 2
<b>Side Connector</b>	Common Interface AV In (Composite Audio/Video)					
	Earphone HDMI 2	Earphone HDMI 2	Earphone HDMI 2	Earphone HDMI 3	Earphone HDMI 3	Earphone HDMI 3
<b>WEIGHT &amp; DIMENSION</b>						
<b>Product Dimension (W x H x D mm)</b>	457.3 x 346 x 170.4	527.9 x 389 x 170.4	594.5 x 430.7 x 184.5	665.2 x 529.4 x 225.5	790.5 x 569.6 x 255.3	1015.4 x 711.2 x 279.5
<b>Net Weight</b>	4.4 kg	4.9 kg	6.9 kg	9.1 kg	11 kg	20.9 kg
<b>POWER</b>						
<b>Operation (Max.)</b>	50 W	60 W	60 W	130 W	130 W	200 W
<b>Standby</b>	< 1 W					
<b>Main Power</b>	AC100~240V 50~60 Hz	AC100~240V 50~60 Hz	AC100~240V 50~60 Hz	AC100~240V 50~60 Hz	AC100~240V 50~60 Hz	AC100~240V 50~60 Hz
<b>Ambient Temperature</b>	5 °C~ 35 °C					



# 7

## Disassembling the stand base

- 1 Disconnect all the cables and cords from the TV to prevent breakage.
- 2 Carefully place the TV face down on a soft and flat surface (blanket, foam, cloth, etc) to prevent any damage to the TV.
- 3 Remove the screws so that the stand base can be removed.
- 4 Gently remove the stand base.

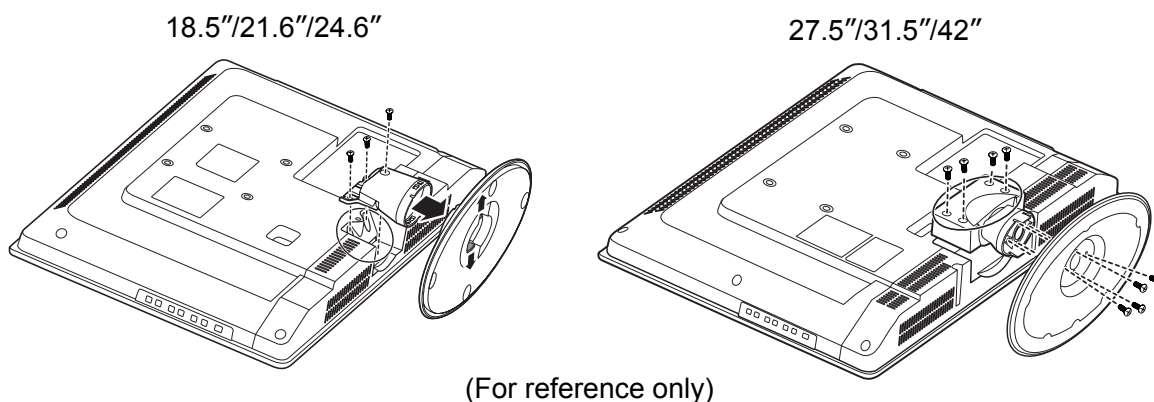

### Wall mounting the TV:

Model Name	VESA-compatible wall bracket (WxH)	Mount holes number	Screw type	Maximum loading
SJ19DMAB	100x100 mm	4	Metric 4 x 10 mm	15 kg
SJ22DMAB	100x100 mm	4	Metric 4 x 10 mm	18 kg
SJ25DMAB	200x100 mm	4	Metric 4 x 10 mm	24 kg
SJ28DMBB	200x100 mm	4	Metric 6 x 10 mm	30 kg
SJ32DMBB	200x200 mm	4	Metric 6 x 10 mm	36 kg
SJ42DMBB	400x200 mm	4	Metric 6 x 10 mm	72 kg

- 1 Purchase a VESA compatible wall bracket (please refer to the table above).
- 2 Locate your ideal TV position on the wall.
- 3 Fix the wall bracket firmly on the wall.
- 4 Secure the TV to the bracket using the 4 mount holes on the back and center of the TV.

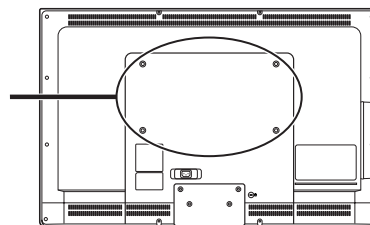

#### Note:

- Please read the instructions of your specific wall bracket to properly wall mount the TV.
- The TV stand base can be screwed on a table or a hard surface using the hole on the back of the stand base.

*\*Installing the LCD TV requires special skill that should only be performed by qualified service personnel. Customers should not attempt to do the work themselves. Hannspeer bears no responsibility for improper mounting or mounting that results in accident or injury. You can ask a qualified service personnel about using an optional bracket to mount the TV to the wall.*

8

## Using the Cable Organizer

Route the cables through the cable clamp as shown:

