

15" LCD Television FLM-1511

Operating Manual



20050314

Congratulations on your purchase of this **LCD TV**.

We recommend that you read this manual thoroughly before use to fully enjoy the many functions and excellent features of this unit.

Keep this manual in an easily accessible location for future reference.

Note:Screen displays and illustrations in this manual may differ from the actual model.

Contents Index

Important safety information	1	Operations	19
Important safety cautions	2	Picture adjustment	19
Identification of controls	5	System setting	20
Control buttons	5	Audio setting	25
Back	6	Channel setting	27
Remote control	7	Selecting channel	29
Installation	9	OSD setting	30
Basic operations	17	Timer setting	31
Main on-screen-display (OSD) introduction	18	Operations in VGA/YbPr mode	32
		TV troubleshooting	34
		Specifications	35

Important Safety Information

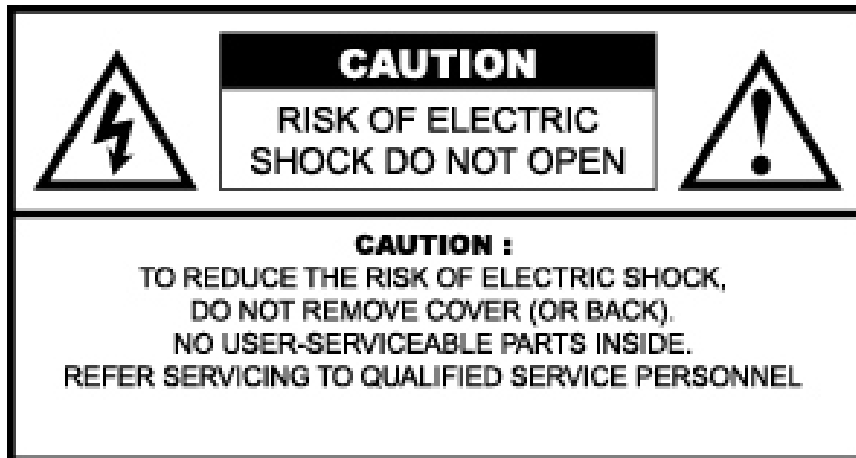

The lightning flash with the arrowhead symbol within an equilateral triangle is intended to alert the user to the presence of uninsulated “**DANGEROUS VOLTAGE**” within the product’s enclosure that may be of sufficient magnitude to constitute a risk of electric shock to persons.



The Exclamation point within an equilateral triangle is intended to alert the user to the presence of important operating and maintenance (Servicing instructions in the literature accompanying the product).

Federal Communication Commission Information (FCC)

This Equipment has been tested and found to comply with the limits for a TV Broadcast Receiver, pursuant to Part 15 of the FCC Rules. These limits are designed to provide reasonable protection against harmful interference in a residential installation. This equipment generates, uses and can radiate radio frequency energy and, if not installed and used in accordance with the instructions, may cause harmful interference to radio communications. If this equipment does cause or receive interference, which can be determined by turning equipment off and on, the user is encouraged to try to correct the interference by one of the following measures:

- ☞ Reorient or relocate the TV antenna
- ☞ Increase the separation between TV and other equipment.
- ☞ Connect TV into separate outlet from equipment.
- ☞ Consult the dealer or an experienced radio/TV technician for help

FCC Caution: Any changes or modifications not expressly approved by the party responsible for compliance could void the user’s authority to operate this equipment

Important Safety Cautions

When any unusual situation occurs, turn off the power supply at once and remove the plug from the wall outlet. Contact a qualified service department in your local area.

Do not expose this unit to rain or spattering liquids. Do not use this product near water - for example, near a bathtub, washbowl, kitchen sink, or laundry tub, in a wet basement, or near a swimming pool, and the like. Do not use immediately after moving from a low temperature to high temperature environment, as this causes condensation, which may result in fire, electric shock, or other hazards.

Heat sources-Keep the product away from heat sources such as radiators, heaters, stoves and other heat generating products (including amplifiers).
Requirement of environment temperature:
0°C~50°C for storage; 5°C~40°C for working

The vents and other openings in the cabinet are designed for ventilation. Do not cover or block these vents and openings since insufficient ventilation can cause overheating and/or shorten the life of the product.
Do not place the product on a bed, sofa, rug or other similar surface, since they can block ventilation openings.
This product is not designed for built-in installation; do not place the product in an enclosed place such as a bookcase or rack, unless proper ventilation is provided or the manufacturer's instructions are followed.

Unplug this product from the wall outlet before cleaning. Do not use liquid cleaners or aerosol cleaners. Use a damp cloth for cleaning.

Do not place the product on an unstable trolley, stand, tripod or table. Placing the product on an unstable base can cause the product to fall, resulting in serious personal injuries as well as damage to the product. Use only a trolley, stand, tripod, and bracket or table recommended by the manufacturer or sold with the product.

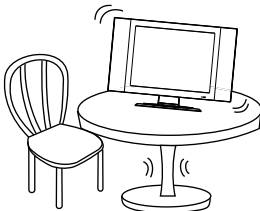
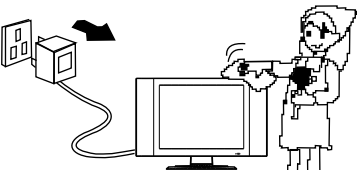
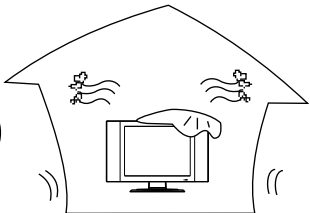
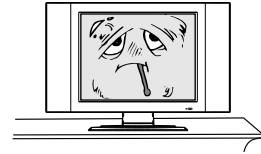

Important Safety Cautions

When relocating the product placed on a trolley, it must be moved with the utmost care. Sudden stops, excessive force and uneven floor surfaces can cause the product to fall from the trolley.



The power cords must be routed properly to prevent people from stepping on them or objects from resting on them. Check the cords at the plugs and product. Power-supply cords should be routed so that they are not likely to be walked on or snagged by items placed upon or against them. Pay particular attention to cords at doors, plugs, receptacles, and the point where they exit from the product. If the power cord or the plug is damaged contact a qualified service department for service.

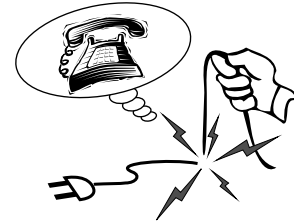

Do not overload wall outlets, extension cords, or convenience receptacles on other equipment as this can result in a risk of fire or electric shock.

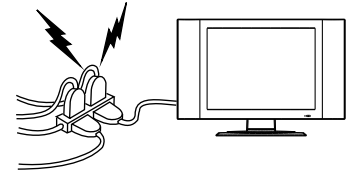

High Voltage exists in this TV set. Do not remove the cover. In case the product needs replacement parts, make sure that the service person uses replacement parts specified by the manufacturer, or those with the same characteristics and performance as the original parts. Use of unauthorized parts can result in fire, electric shock and/or other danger.



The LCD panel used in this product is made of glass. Therefore, it can break when the product is dropped or impacted upon by other objects. Be careful not to be injured by broken glass pieces in case the LCD panel breaks.

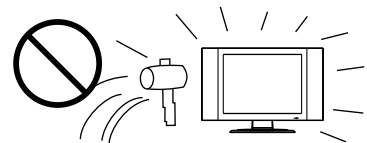

Don't try to push anything into the cabinet or place any vessel with water on the TV set.

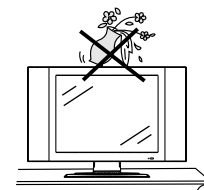

For added protection for this television equipment during a lightning storm, or when it is left unattended and unused for long periods of time, unplug it from the wall outlet and disconnect the antenna. This will prevent damage to the equipment due to lightning and power-line surges.

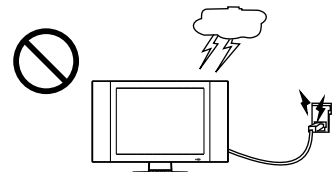

Important Safety Cautions

Important Information Regarding use of Video Games, Computer, captions or other fixed images displays

The extended use of a fixed image program material can cause permanent "Shadow Image" on the LCD panel. This image is visible during normal programs as stationary fixed images. This type of irreversible LCD panel deterioration can be limited by observing the following steps:

- * Reduce the Brightness and Contrast settings to a minimum viewing level
- * DO NOT display the fixed image for extended periods of time
- * Turn the power OFF when not in actual use

Recycling

This product utilizes tin-lead solder, and has a fluorescent lamp containing a small amount of mercury. Disposal of these materials may be regulated in your community due to environmental considerations. For disposal or recycling information please contact your local authorities, or the Electronics Industries Alliance Environment at: <http://www.eiae.org/>

Identification of controls

Control buttons

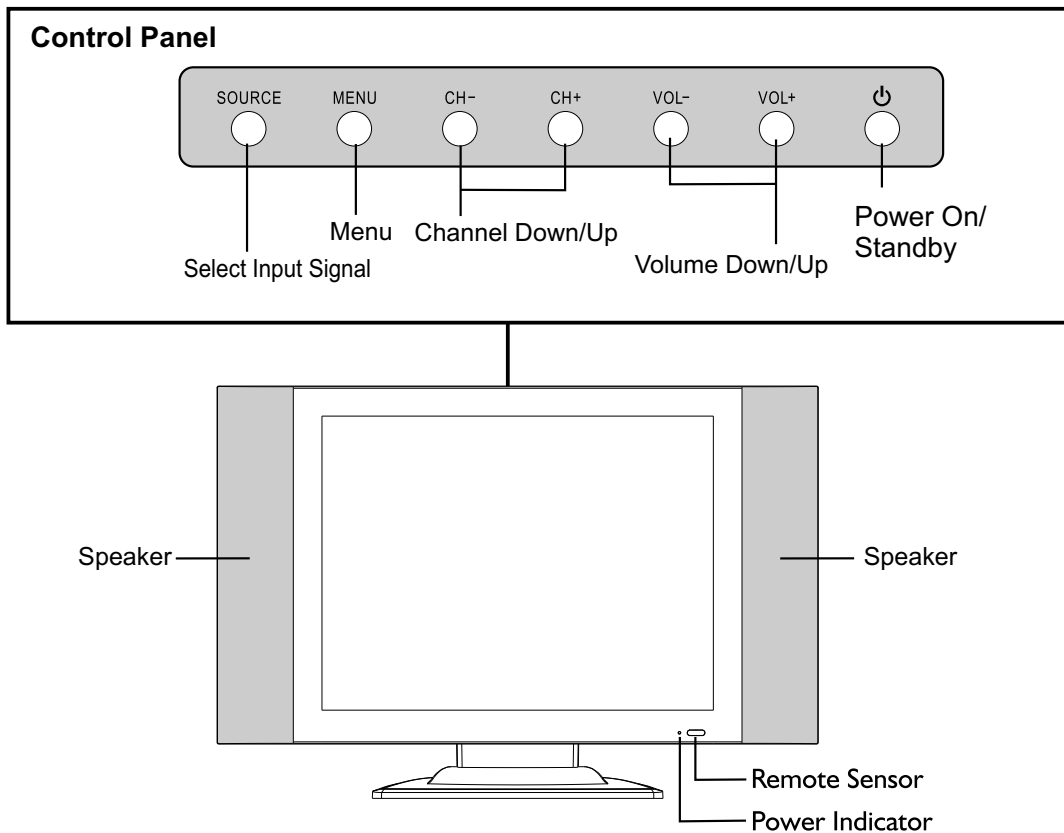

1. SOURCE

To access the SOURCE select menu

2. MENU

Press this button to access the MENU main page.

3. CH +/-

Change the TV channel.

In OSD Menu, press these buttons to choose the OSD items.

4. VOL +/-

Increase or decrease the sound volume level.

In OSD Menu, press these buttons to adjust the value or setting of each item

5. POWER (⏻)

Press this button to turn the unit ON from STANDBY mode. Press it again to turn the set back to STANDBY.

The Power Indicator light will glow yellow when the set is turned on, and glows red when the set is in the standby mode.

Note:

SOURCE, MENU, CH+/-, VOL+/- and POWER (⏻) on the main unit have the same functions as the corresponding buttons on the remote control.

This operation manual provides a description based on operating functions with the remote control.

Identification of controls (continued)

Back

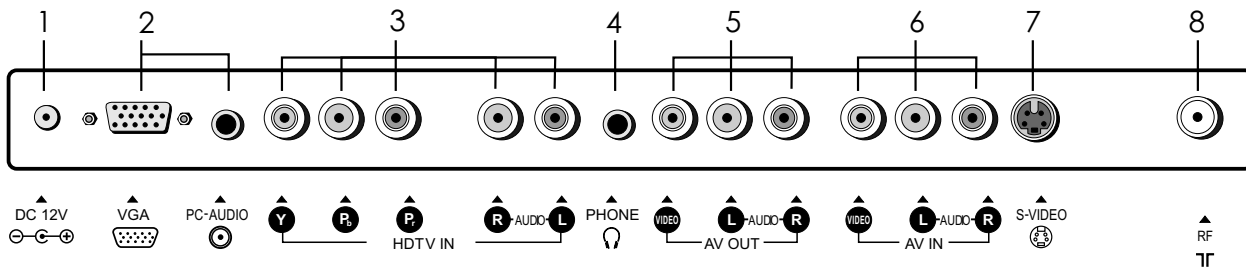
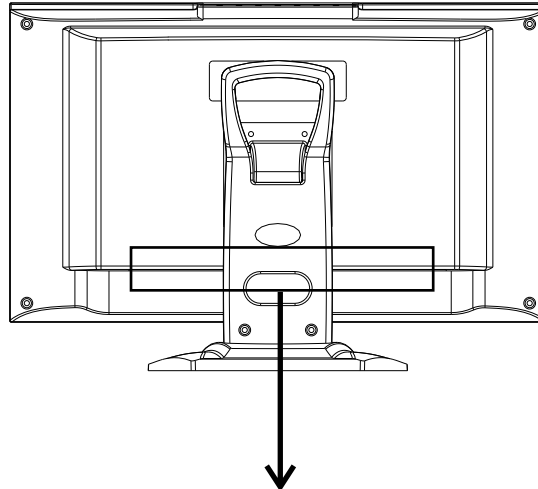

1. DC POWER input

Connect to the DC output of the Power Adapter.

2. VGA input / PC-Audio in

Connect to the VGA/audio output \varnothing 3.5mm jacks on your PC.

3. HDTV input (Y, Pb, Pr, Audio L, R)

Connect to the Y/Pb/Pr (or Y/Cb/Cr) and audio output jacks of a Set-Top Box or DVD player.

4. Headphone \varnothing 3.5mm jack

5. AV outputs (Video, Audio L, R)

Connect to the VCR input jacks to record programs.

6. AV inputs (Video, Audio L, R)

Receive video/audio signals from external sources such as VCR or DVD player.

7. S-Video input

Receive a S-Video signal from external source such as VCR or DVD player.

8. Coaxial cable & Antenna input

Remote Control

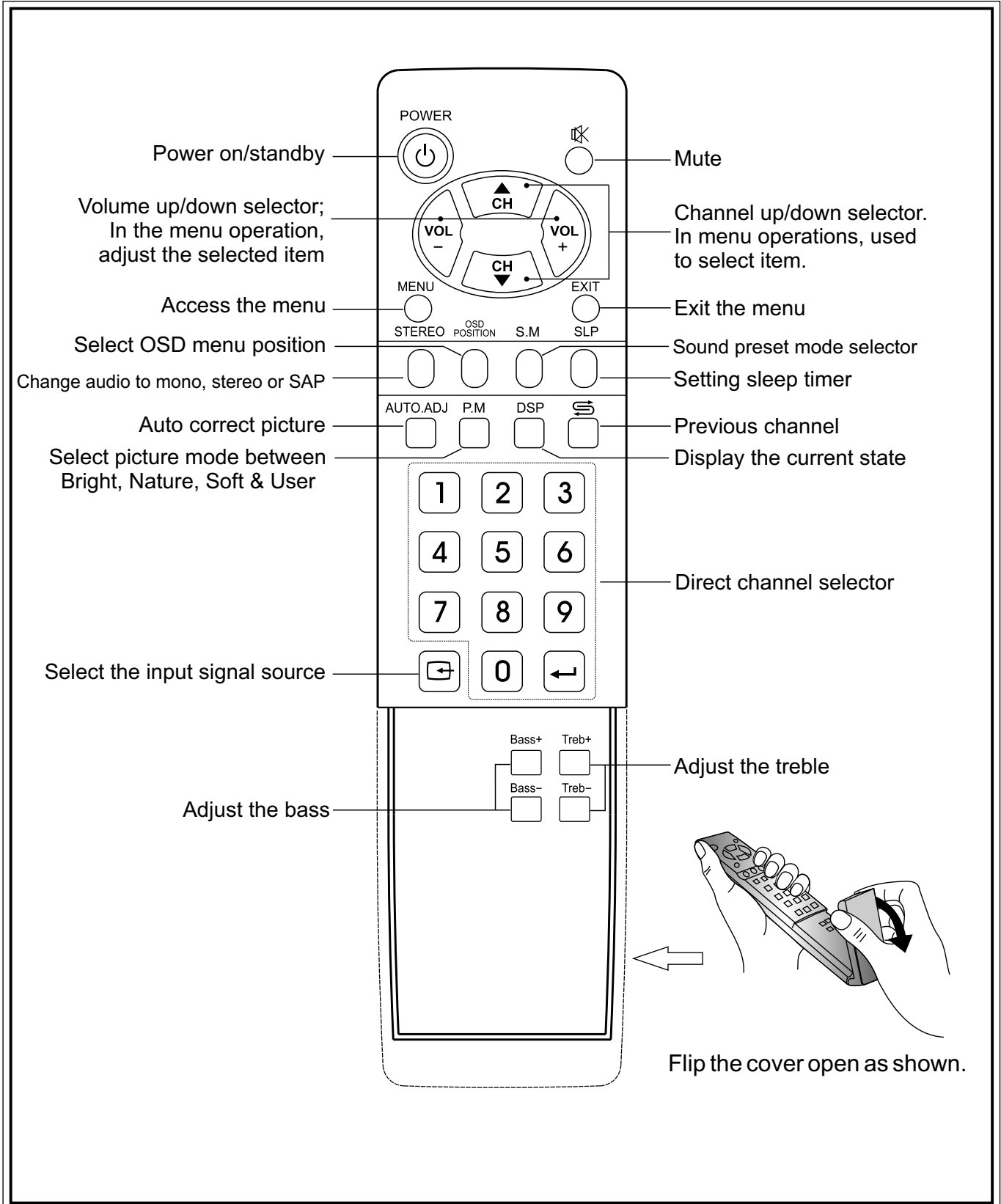

Preparing the Remote Control

Please install the batteries before using the remote control.

Batteries for the Remote Control

If the remote control fails to operate the LCD TV functions, replace the batteries in the remote control.

1 Open the battery cover.

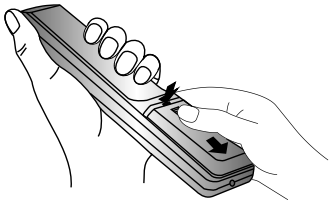

■(Slide the cover while pressing down.)

2 Insert two size-AAA batteries.

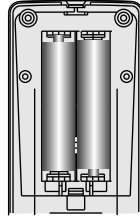

■(Place the batteries with their terminals corresponding to the (+) and (-) indications in the battery compartment.)

3 Replace the cover and slide in reverse until the lock snaps.

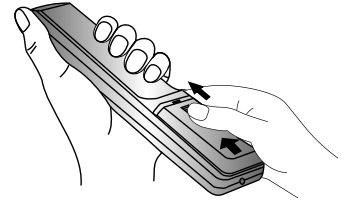

Effective range of the remote control

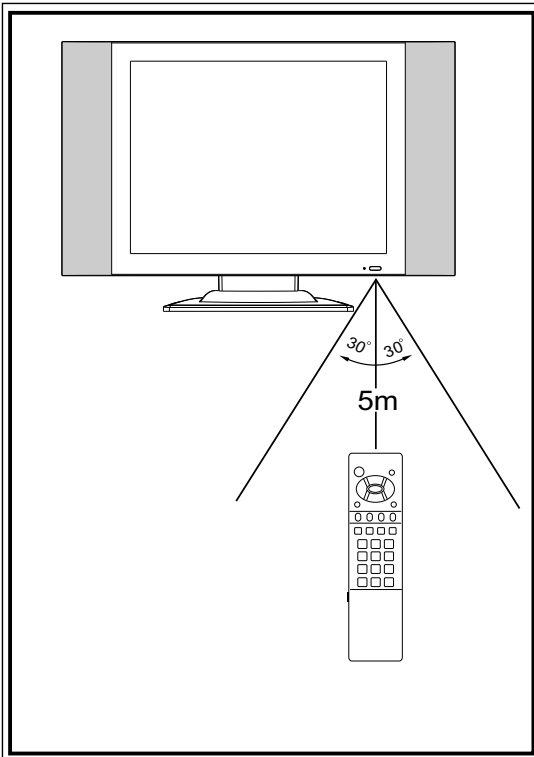

! Notes:

1. When the remote control will not be used for a long period of time or when the batteries are worn out, remove the batteries.
2. Do not drop or dampen the remote control.
3. Do not disassemble the remote control.
4. There should be no obstacle between the TV and the transmitter.
5. Use the remote control within the effective range as shown in the figure on the left.
6. If the remote control does not work, please check whether the batteries are exhausted or if they have been installed properly.
7. When direct sunlight, and incandescent lighting, fluorescent lamp or any other strong light shines on the remote sensor of the TV, the remote operation can become erratic.
8. Do not mix different types of batteries in the remote.

Install the unit in a room where direct light will not fall upon the screen. Total darkness or a reflection on the picture screen may cause eyestrain. Soft and indirect lighting is recommended for comfortable viewing.

Installation

Antenna connections

OUTDOOR VHF/UHF ANTENNA CONNECTION (ANTENNA NOT INCLUDED)

Follow the instructions for the type of antenna system you intend to use. If using Cable or satellite, see the next page.

Combination VHF/UHF Antenna (Single 75 Ohm cable or 300 Ohm twin-lead wire)

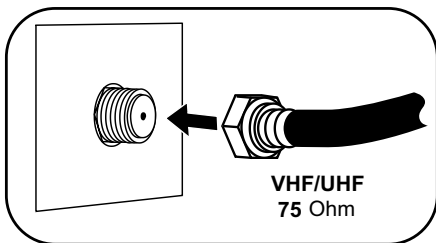

Connect the 75 Ohm cable from combination VHF/UHF antenna to the antenna jack.

OR

If your combination antenna has a 300 Ohm twin-lead wire, use a 300-75 Ohm matching transformer (NOT SUPPLIED).

Combination VHF/UHF Antenna (Separate VHF and UHF 300 Ohm twin-leads)

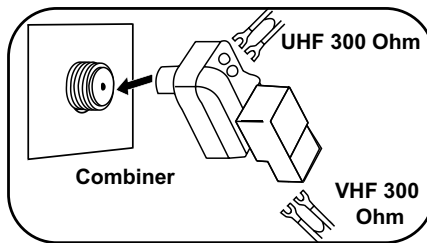

Connect the UHF twin-lead wire to a combiner (NOT SUPPLIED). Connect the VHF twin-lead to a 300-75 Ohm matching transformer (NOT SUPPLIED). Attach the transformer to the combiner. Attach the combiner to the antenna jack.

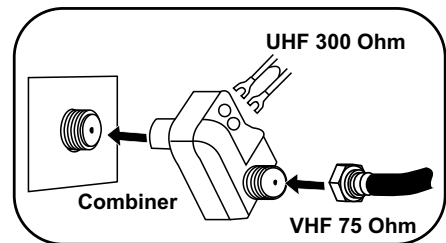

Connect the 75 Ohm cable from the VHF antenna and the UHF antenna twin-lead wire to a combiner (NOT SUPPLIED). Attach the combiner to the antenna jack.

NOTE: If your VHF antenna has a twin-lead wire use a 300-75 Ohm matching transformer, then connect the transformer to the combiner.

Installation

Cable (CATV)/satellite connections

This TV has an extended tuning range and can tune most cable channels without using a Cable TV converter box. Some Cable TV companies offer "premium pay channels" in which the signal is scrambled. Descrambling these signals for normal viewing requires the use of a descrambler device which is generally provided by the cable company.

FOR SUBSCRIBERS TO BASIC CABLE TV SERVICE

For basic cable service not requiring a converter/descrambler box, connect the CATV 75 ohm coaxial cable to the VHF/UHF jack on the rear of the TV.

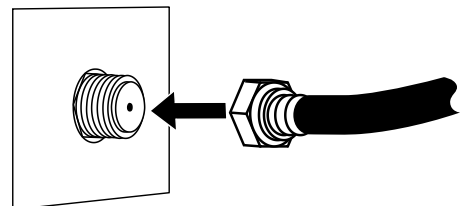

FOR SUBSCRIBERS TO SCRAMBLED CABLE TV SERVICE OR SATELLITE

If you subscribe to a satellite service or a cable TV service which requires the use of a converter/descrambler box, connect the incoming 75 Ohm coaxial cable to the converter/descrambler box. Using another 75 Ohm cable, connect the output of the converter/descrambler or satellite box to the antenna jack on the TV. Follow the connections shown below. Set the TV/VCR to the output channel of the converter/descrambler or satellite box (usually 3 or 4) and use the converter/descrambler or satellite box to select channels.

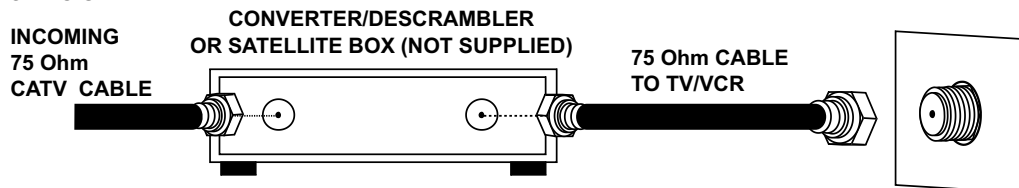

FOR SUBSCRIBERS TO UNSCRAMBLED BASIC CABLE TV SERVICE WITH SCRAMBLED PREMIUM CHANNELS

If you subscribe to a satellite service or a cable TV service in which basic channels are unscrambled and premium channels require the use of a converter/descrambler box, you may wish to use a signal splitter and an A/B switch box (available from the cable company or an electronic supply store). Follow the connections shown below. With the switch in the "B" position, you can directly tune any unscrambled channels on your TV. With the switch in the "A" position, tune your TV to the output of the converter/descrambler box (usually channel 3 or 4) and use the converter/descrambler box to tune scrambled channels.

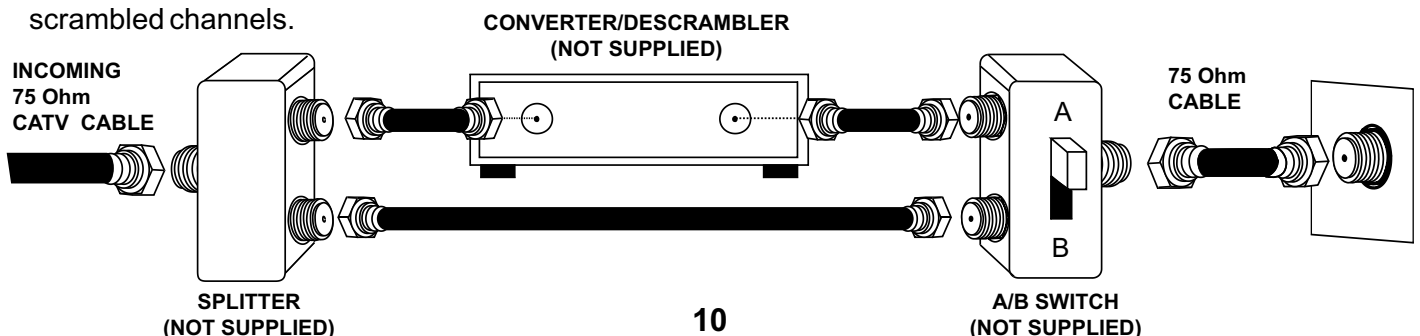

Installation(continued)

Power connection

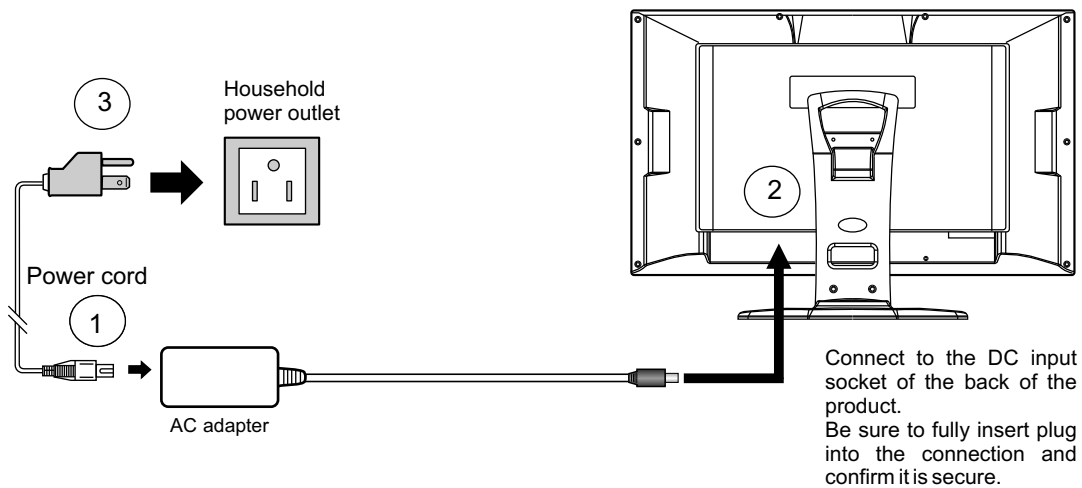

1. Connecting the female plug to the AC socket on AC adapter.
2. Connecting the AC adapter to the DC power input of the set.
3. Connecting the male plug to the wall outlet as illustrated.

Note:

- Always turn off the Power to the LCD TV when connecting the AC adapter.
- This product should only be operated with the type of power source marked on the label on the unit.
- Always unplug the AC adapter from the product and power outlet when the LCD TV is not in use for an extended period of time.
- The illustration of power cord and power outlet is only for your reference and may vary depending on your area.

Installation(continued)

Elevation adjustment

You can adjust the angle of the LCD TV as follows.
The elevation can be adjusted from -5° to $+10^{\circ}$ average.

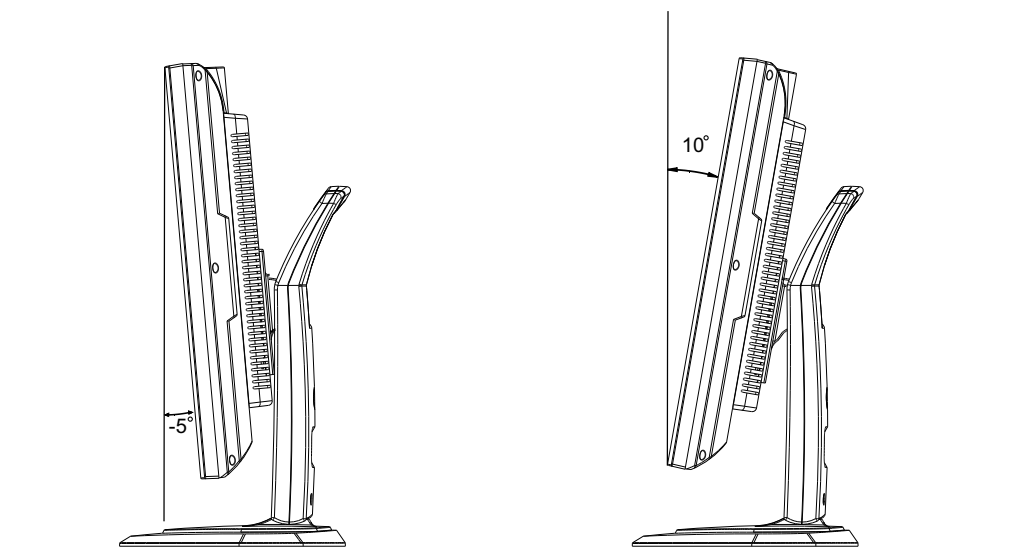

Installation(continued)

Notes about connection

1. Carefully check the terminals for position and type before making any connections.
2. Loose connectors will result in image or color problems. Make sure that all connectors are securely inserted into their terminals.
3. When connecting an external device, turn off the power of the main unit first to prevent any possible damage.

Connecting the Video/Audio equipment

You can connect the unit to a DVD or VCR to enjoy playback with high quality picture and sound. Please refer to the instruction manual of the equipment to be connected.

Composite Video signal connection

Connect the composite video signal terminal on the TV to the output of AV equipment through composite cable. If you select the video signal, please set the input signal source of LCD TV to **AV** mode.

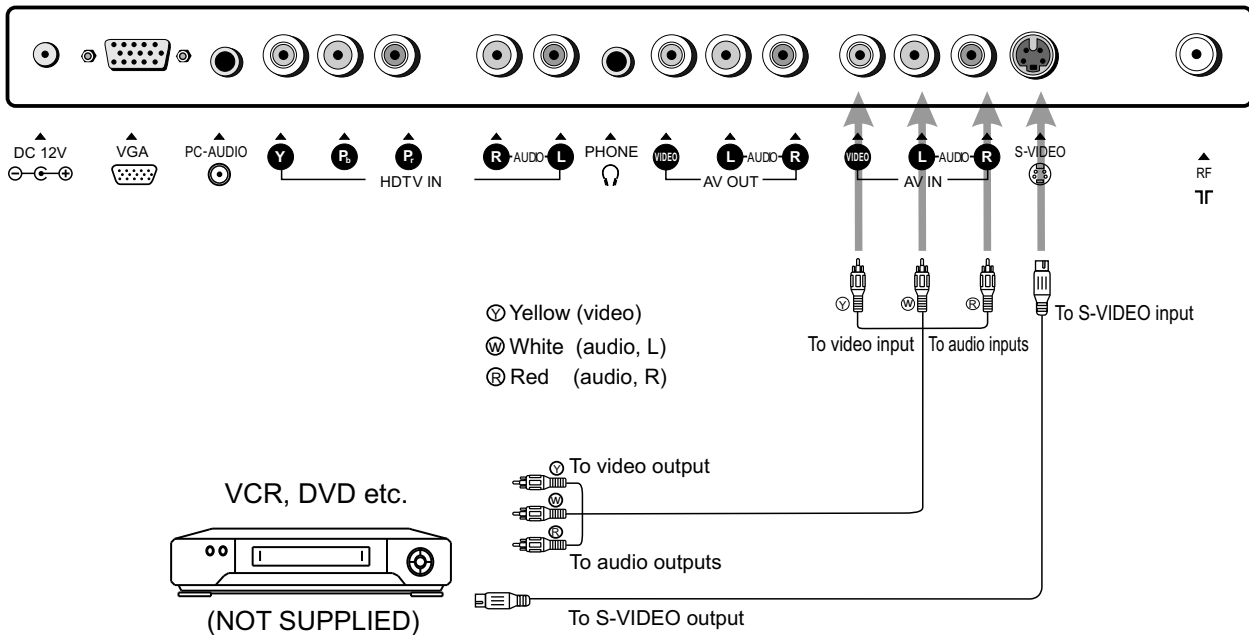

Note: Composite video is the most common used signal, but the picture quality is not as high as S-video.

S-VIDEO Signal Connection

Connect the S-video terminal on the TV to the output of AV equipment using a S-video cable. If you select S-video signal, please set the input signal source of LCD TV to **SVIDEO** mode.

S-Video is a signal format which transfers the color and brightness of the picture with higher quality than a Composite connection. The S-Video signal connection is recommended to produce the best picture.

Installation(continued)

The PC input signal connection

Connect the VGA (D-sub) input interface on the TV to the output of the PC D-sub 15 pin cable as illustrated. For the audio connection, use an audio cord that matches the audio output terminal on the computer. If you select PC signal, please set the input signal source of LCD TV to **VGA** mode.

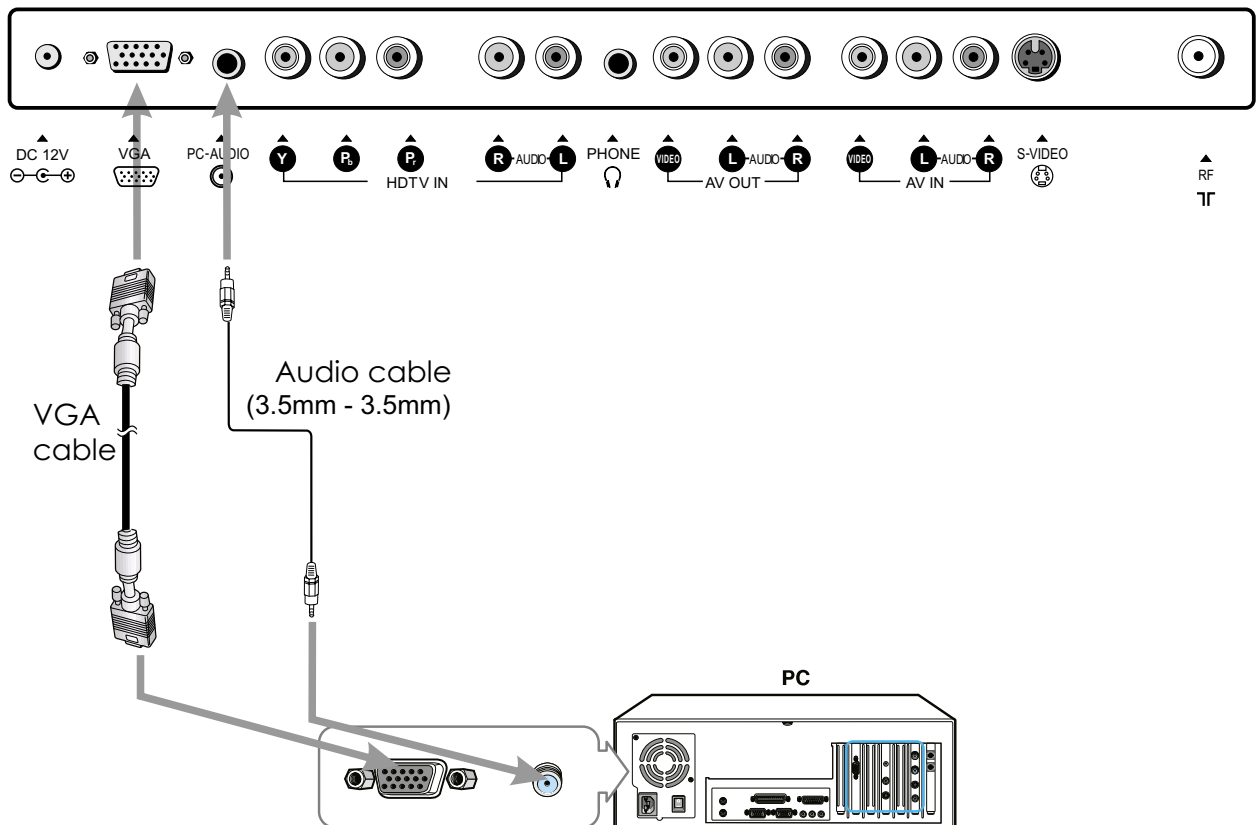

! Notes:

1. The native display resolution is 1024 x 768. If the signal resolution exceeds this resolution, it may not be possible to show fine detail with sufficient clarity.
2. We strongly recommend that you set the refresh rate on the PC to 60Hz. If you set it above 60Hz, the unit may not display correctly. (Control Panel/Display Settings)
3. Use the OSD to make final image adjustments.

Installation(continued)

AV OUT connection

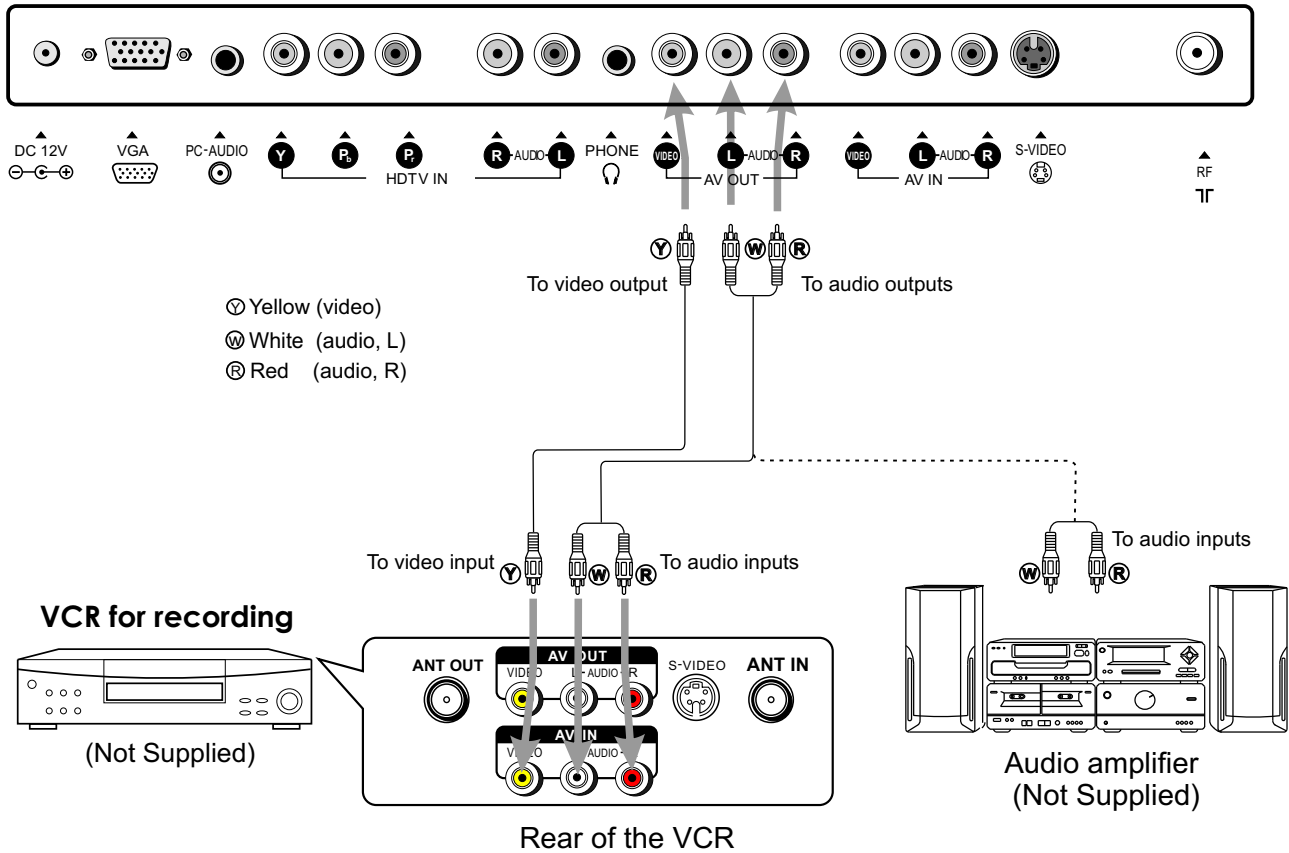

How to connect:

Connect the video/audio output terminals on the TV set to the signal input terminals of the VCR equipment or the video/audio input terminals on other TV set through a video/audio cable.

Connect the audio output terminals on the TV set to the Audio amplifier through audio cable.

How to record the TV program:

1. Connect cables as shown above.
2. Turn on the LCD TV and select source.
3. Turn on the VCR and insert the tape.
4. Select the video input from the VCR menu that corresponds to the AV in on the VCR.
5. Press the "RECORD" button to begin recording.

How to enjoy high quality sound by Audio amplifier:

1. Connect cables as shown above.
2. Turn the volume of the Audio amplifier to minimum.
3. Turn on the LCD TV and select source.
4. Connect the RCA (Red/White) cable from the TV AV OUT to the AUX input on the back of the Audio Amplifier.
5. Set the Audio Amplifier to AUX INPUT.
6. Turn on the audio amplifier and adjust for a proper volume.

Installation(continued)

YPbPr input connection

Use the YPbPr input terminals on the TV set for better picture quality. Connect the audio outputs with the corresponding audio input terminals on the TV set.

If you select YPbPr signal, please set the input signal source of the LCD TV to **YPbPr / YCbCr** mode.

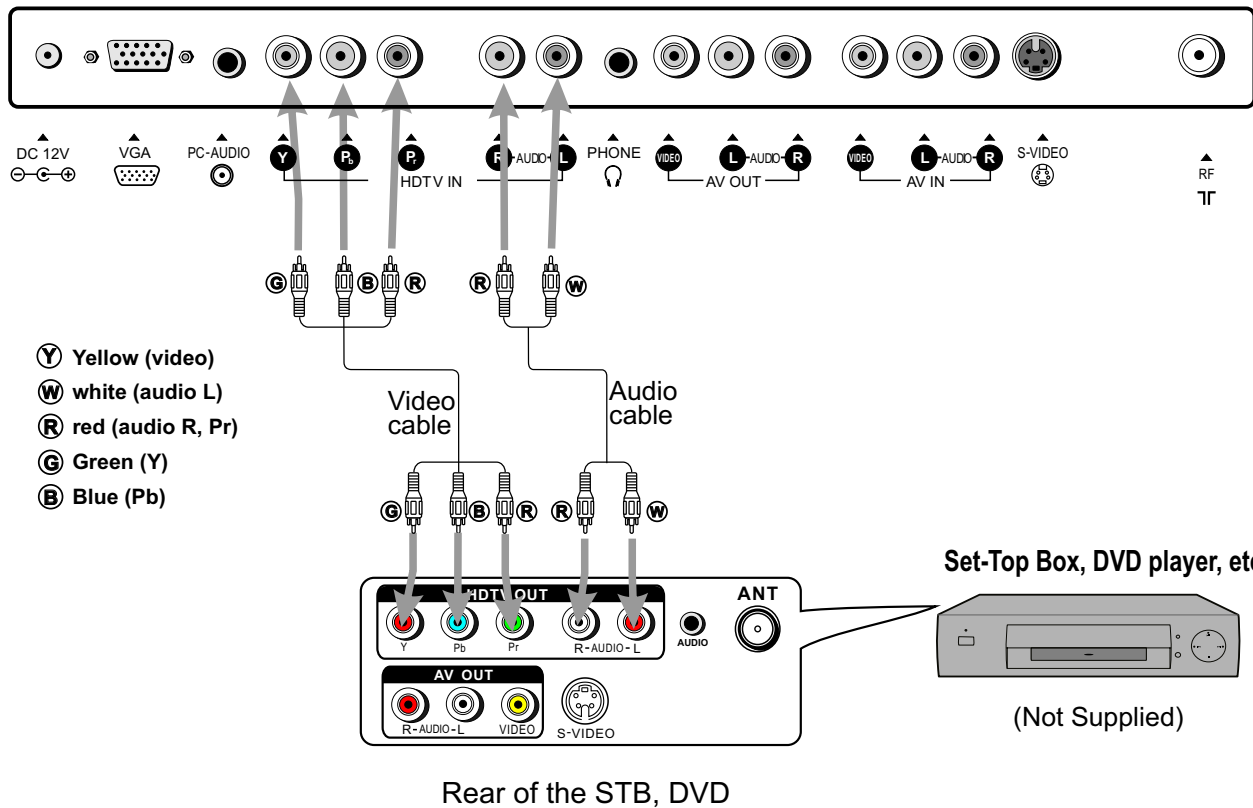

Notes:

The Y, Pb, Pr outputs on your DVD player are sometimes labeled Y, Cb, Cr. If so, connect the cables to like colors.

Basic Operations

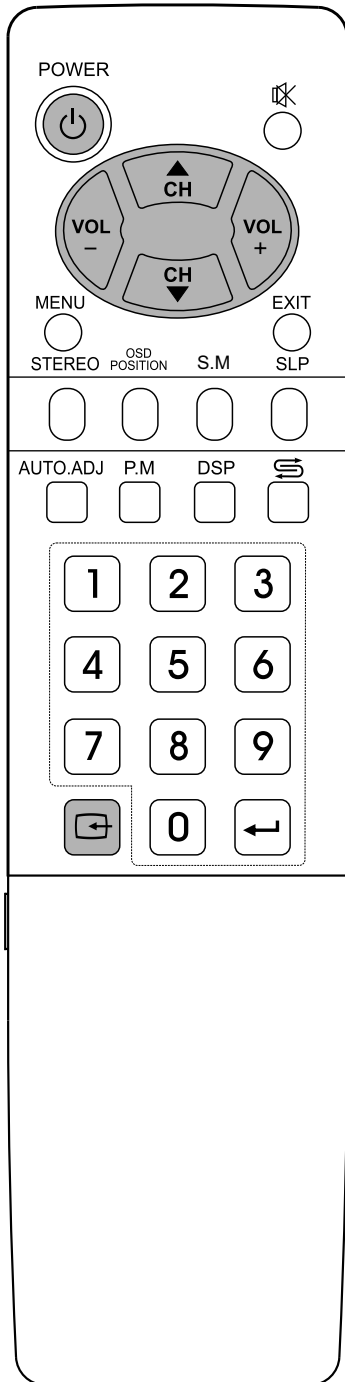

Turning on





- 1 Connect the AC power and the red indicator lights up to show the unit is in STANDBY mode.
- 2 Press the **POWER** (⏻) button on the remote control or on the unit to turn on the TV set. The indicator LED will turn to yellow.

Turning off

- 1 With the power on, press the **POWER** (⏻) button to turn off the TV and put the TV in STANDBY mode, the indicator LED will turn to red.
- 2 If you want to turn off the power completely, unplug the power cord from the wall outlet.

Note: Do not switch the unit on and off quickly. Wait at least 5 seconds between switching the unit off or on.

Selecting input signal

- 1 Press the **SOURCE** button on the unit or  button on the remote control. The screen displays the menu as shown on the right.
- 2 Press **CH**  /  to highlight your desired input signal source. Press **VOL**  /  or wait for about 4 seconds and the desired signal

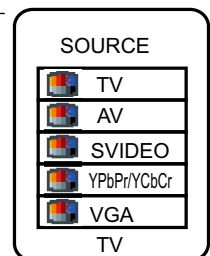

Note: All buttons shown in the manual are located on the remote control unless otherwise indicated.

Main On-Screen-Display (OSD) introduction

- 1 Press **MENU** button to display menu screen.
- 2 Press **VOL+/-** to select the menu.
- 3 Press **CH ▾** to access the menu.
- 4 Press **CH ▲/▾** to select the item.
- 5 Press **VOL+/-** to adjust the item.
6. Press **EXIT** button twice to exit the menu.

TV/AV/S-VIDEO MODE

Picture Setting Menu

brightness	<input type="text" value="50"/>	50
contrast	<input type="text" value="50"/>	50
color	<input type="text" value="18"/>	18
sharpness	<input type="text" value="32"/>	32
tint	<input type="text" value="0"/>	0

System Setting Menu

blue screen	on
backlight	<input type="text" value="6"/> 6
ccd mode settings	CC 1
parental control settings	---

Audio Setting Menu

SRS	on	off	
MTS	mono	stereo	SAP
bass	<input type="text" value="0"/>	0	
treble	<input type="text" value="0"/>	0	
balance	<input type="text" value="0"/>	0	

Channel Setting Menu

channel number	9	
antenna/cable	antenna	cable
add/erase	add	erase
fine tune	<input type="text" value="48"/>	48
channel search	→	

OSD Setting Menu

language	English	
OSD position	<input type="checkbox"/> <input type="checkbox"/> <input type="checkbox"/> <input type="checkbox"/> <input type="checkbox"/> <input type="checkbox"/> <input type="checkbox"/> <input type="checkbox"/> <input type="checkbox"/> <input type="checkbox"/>	
OSD background	opaque	translucent
OSD timeout	30 seconds	

Signal Information Menu

video type:	650 X 462/60Hz
mode:	3

YPbPr/YCbCr/VGA MODE

Picture Setting Menu

brightness	<input type="text" value="50"/>	50		
contrast	<input type="text" value="50"/>	50		
color temp	5000K	7300K	9300K	user
customer temp setting	→			

Picture Position MENU

h position	<input type="text" value="50"/>	50
v position	<input type="text" value="50"/>	50
phase	<input type="text" value="15"/>	15
frequency	<input type="text" value="866"/>	866

Audio Setting Menu

SRS	on	off
bass	<input type="text" value="0"/>	0
treble	<input type="text" value="0"/>	0
balance	<input type="text" value="0"/>	0

System Setting Menu

sleep time	20	minutes
Back light	<input type="text" value="6"/>	6

OSD Setting Menu

language	English	
OSD position	<input type="checkbox"/> <input type="checkbox"/> <input type="checkbox"/> <input type="checkbox"/> <input type="checkbox"/> <input type="checkbox"/> <input type="checkbox"/> <input type="checkbox"/> <input type="checkbox"/> <input type="checkbox"/>	
OSD background	opaque	translucent
OSD timeout	30 seconds	

Signal Information Menu

resolution:	640 X 480/60Hz
mode:	40

Note: in AV/S-VIDEO mode, **Channel Setting** menu can not be accessed and there is no **MTS** menu item in **Audio Setting** menu.

Note: in YPbPr/YCbCr mode, there are no **color temp** and **customer temp setting** menu items in **Picture Setting** menu.

Operations

Picture adjustment

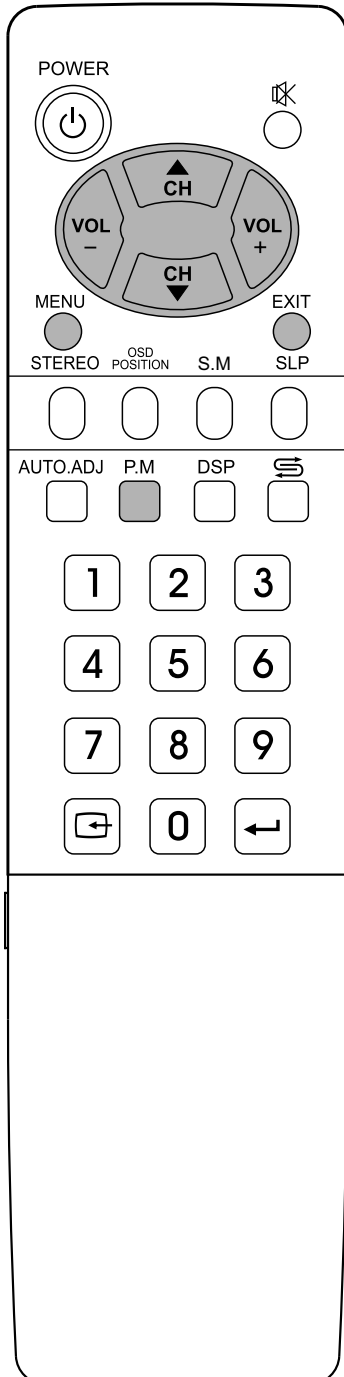

1 Access **Picture Setting** menu by pressing **MENU**.

2 Press **CH ▲/▼** to select the item that you want to adjust.

3 Press **VOL+/-** to adjust selected item.

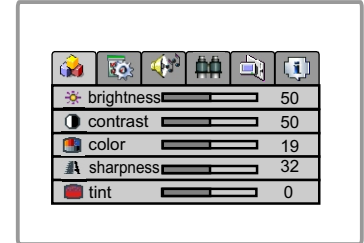

Item	Function	Range
brightness	To adjust picture's brightness	0-100
contrast	To adjust picture's contrast	0-100
color	To adjust picture's color	0-36
sharpness	To adjust picture's sharpness	0-63
tint	To adjust picture's tint	-32-+31

You can select picture mode by **P.M** button. There are four picture modes: **Bright, Nature, Soft** and **User**.

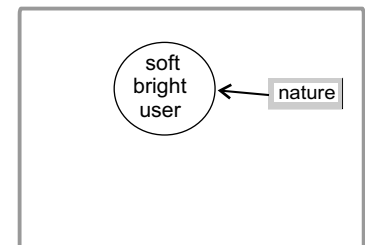

Bright: Select for a bright picture.

Nature: Select for a standard picture.

Soft: Select for a soft picture.

NOTE: Setting the unit to a Bright Picture with high brightness and contrast levels will cause picture quality loss.

Operations (continued)

System setting

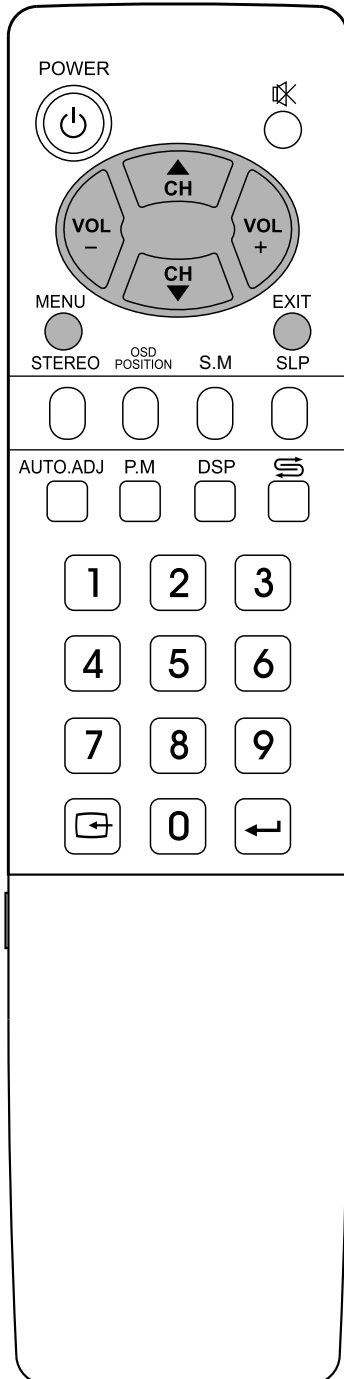

blue screen setting

- 1 Access the **System Setting** menu.
- 2 Press **CH ▲/▼** to select **blue screen** item.
- 3 Press **VOL+/-** to select **off** or **on**.

If you select **on**, the screen displays blue background when there is no signal. If you select **off**, the screen displays static when there is no signal.

! Note: Only when the blue screen is **on**, the set will turn off automatically after 15 minutes if there is no signal.

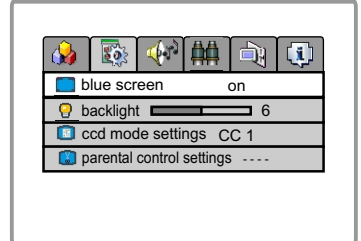

backlight adjustment

- 1 Access the **System Setting** menu.
- 2 Press **CH ▲/▼** to select **backlight** item.
- 3 Press **VOL+/-** to adjust the backlight brightness.

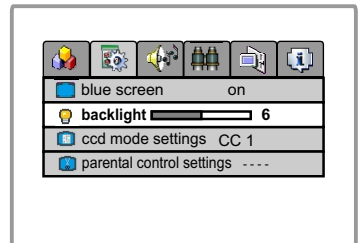

Operations (continued)

System setting

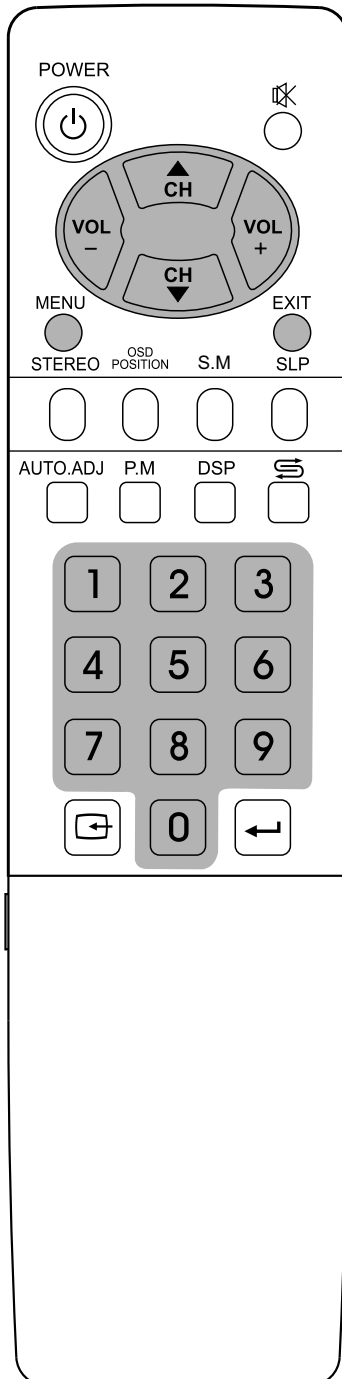

Setting Closed Caption(CCD)

- 1 Access the **System Setting** menu.
- 2 Press **CH ▲/▼** to select **ccd mode settings** item.
- 3 Press **VOL+/-** to select . You can select the caption data channel (CC1, CC2, CC3, CC4), the text service channel(text1, text2, text3, text4) or turn off the Closed Caption(Off).

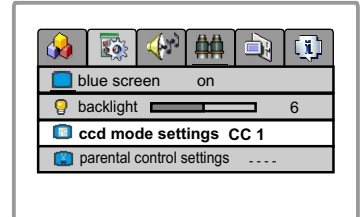

! Note:

1. Some TV programs may not be broadcast with closed caption signals, and therefore the TV will not be able to display captions, Also, text information is not offered by all stations.
2. Some TV programs only provide one channel caption, one channel text, or only caption without text.

Parental Control Setup

- 1 Access the **System Setting** menu.
- 2 Press **CH ▲/▼** to select **parental control settings** item.
- 3 Enter the password using the keypad to access the Parental control sub-menu.(The default password is 1234 and you should change the password after you access the sub-menu.)
- 4 Press **CH ▲/▼** to select **global setting** item. Use **VOL+/-** to select **disable** or **enable**. If you select **enable**, the function is activated. If you select **disable**, the function is not active.

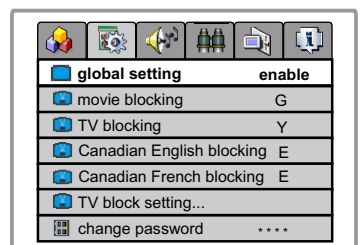
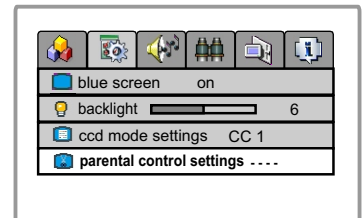

Operations (continued)

System setting (Parental Control Sub-menu)

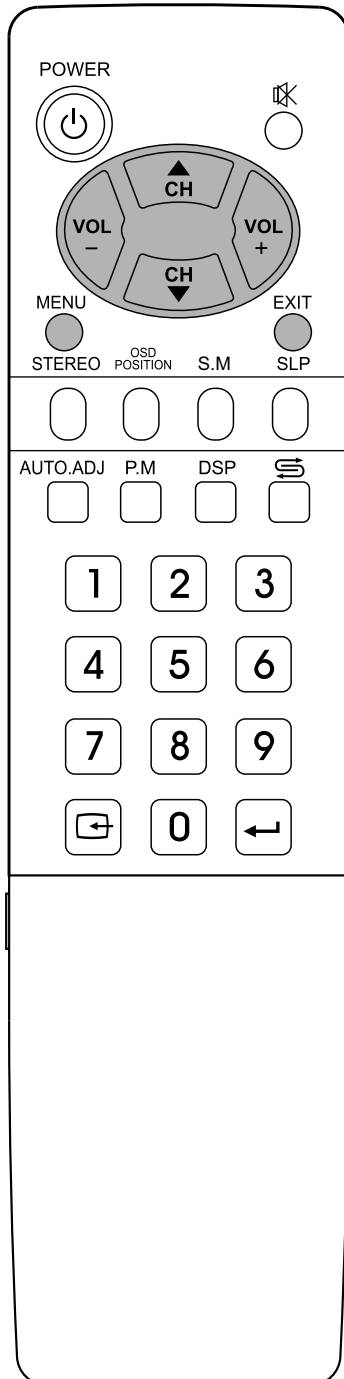

Movie Blocking setting

This function allows programs to be restricted and TV usage to be controlled based on program rating. It prevents children from watching violent or sexual scenes that may be harmful.

Please enter the parental control sub-menu first.

- 1 Press **CH ▲/▼** button to select **movie blocking** item.
- 2 Press **VOL +/-** button to select desired rating.

global setting	enable				
movie blocking	G				
TV blocking	Y				
Canadian English blocking	E				
Canadian French blocking	E				
TV block setting...					
change password	****				

Movie Ratings:

- * NONE
- * G and Above (general audience)
- * PG and Above (parental guidance suggested)
- * PG-13 and Above (13 years and up)
- * R and Above (restricted)
- * NC-17 and Above (18 years and up)
- * X (adult)

If you set PG-13, G and PG movies will be available, and PG-13, R, NC-17 and X will be blocked.

TV blocking setting

This function allows TV programs to be restricted and TV usage to be controlled based on age and content. It prevents children from watching violent or sexual scenes that may be harmful.

Age base

Please enter the parental control sub-menu first.

- 1 Press **CH ▲/▼** button to select **TV blocking** item.
- 2 Press **VOL +/-** button to select the desired rating.

global setting	enable				
movie blocking	G				
TV blocking	Y				
Canadian English blocking	E				
Canadian French blocking	E				
TV block setting...					
change password	****				

TV Ratings:

- * NONE
- * Y and Above (all children) (individual content categories do not apply)
- * Y7 (7 years and up)
- * G and above (general audience) (individual categories do not apply)
- * PG and Above (parental guidance suggested)
- * 14 and above (14 years and up)
- * MA (mature audience)

Parental Control enables parents to prevent their children from watching inappropriate material on TV. Parental Control reads the ratings for programming (except for news, sports, unedited movies on premium cable, and Emergency System signals), then denies access to programming if the program's rating meets the limitations you select. In this case, the program will be blocked.

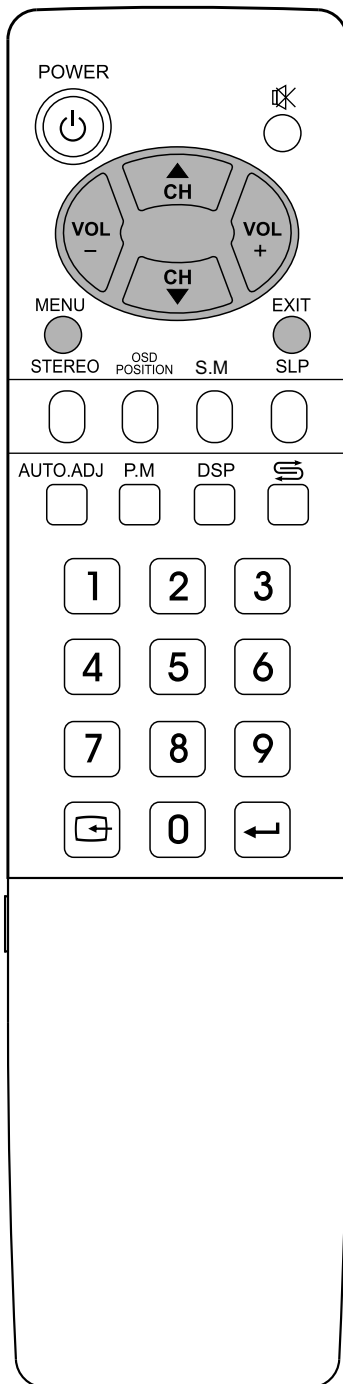

Content based

Please enter the parental control sub-menu first.

1 Press **CH ▲/▼** button to select **TV blocking setting...** item.

2 Press **VOL+** button to access the sub-menu.

3 Setting the content with **CH ▲/▼** and **VOL+/-** buttons.

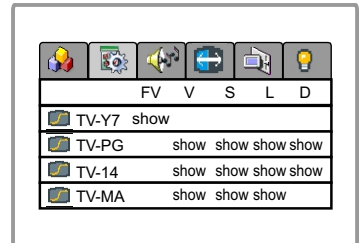
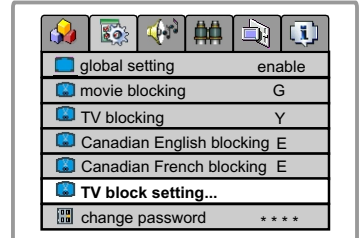

Content Categories:

* FV: fantasy violence

* V: violence

* S: sexual situations

* L: adult language

* D: sexual dialogue

(applies only to TV-Y7)

(applies to TV-PG and above, TV-14 and Above, TV-MA)

(applies to TV-PG and above, TV-14 and Above, TV-MA)

(applies to TV-PG and above, TV-14 and Above, TV-MA)

(applies to TV-PG and Above, TV-14)

Canadian English Blocking setting

Please enter the parental control sub-menu first.

1 Press **CH ▲/▼** button to select **Canadian English blocking** item.

2 Press **VOL+/-** button to select the desired rating.

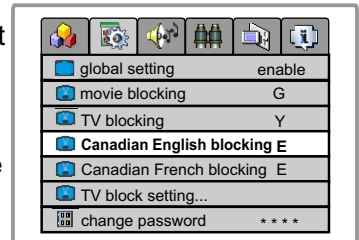

Canadian English Language Ratings:

* E: Exempt.

* C: Children.

* C8+: Children 8 years and older.

* G: General programming, suitable for all audiences.

* PG: Parental guidance.

* 14+: Viewers 14 years and older.

* 18+: Adult programming.

Operations (continued)

System setting (Parental Control Sub-menu)

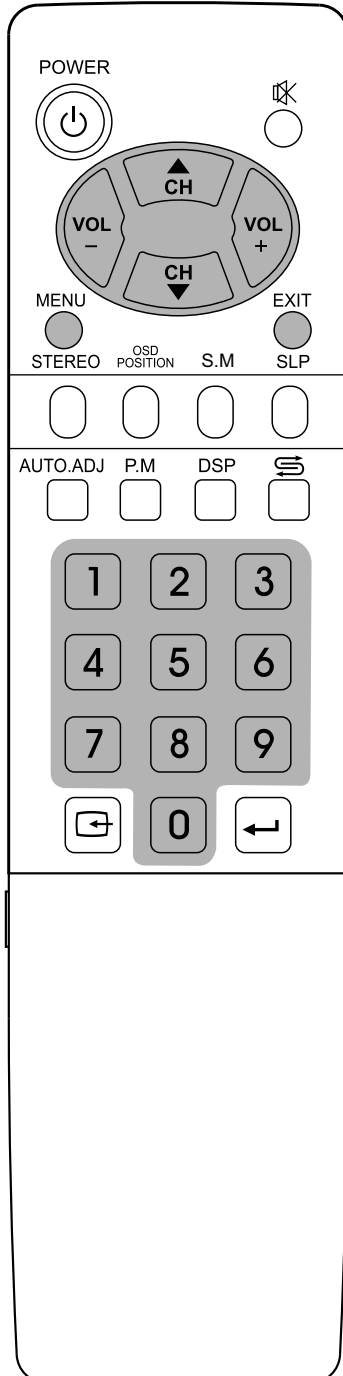

Canadian French blocking setting

Please enter the parental control sub-menu first.

- 1 Press **CH ▲/▼** button to select **Canadian French blocking** item.
- 2 Press **VOL +/-** button to select desired rating

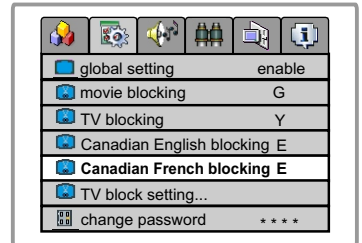

Canadian French Language Ratings:

- * E: Exempt.
- * G: Children.
- * 8 ans+: Children 8 years and older.
- * 13 ans+: Children 13 years and older.
- * 16 ans+: Viewers 16 years and older.
- * 18 ans+: Adult programming.

Changing the password

Please enter the parental control sub-menu first.

- 1 Press **CH ▲/▼** button to select **change password** item.
- 2 Input a new 4-digit password by using the keypad on the remote.

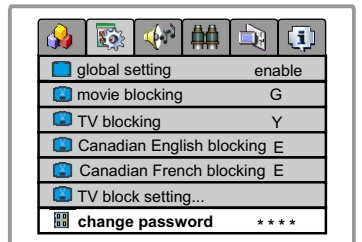

Next time when you want to access the **parental control** menu, you will use your new password. Make sure to remember the password.

Operations (continued)

Audio Setting

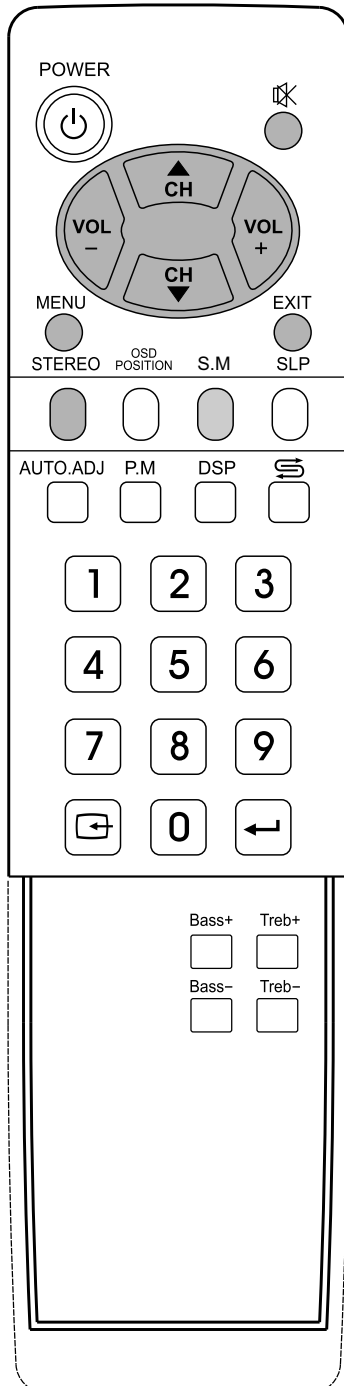

Selecting the MTS

- 1 Access the **Audio Setting** menu.
- 2 Press **CH ▲/▼** to select **MTS** item.
- 3 Press **VOL+/-** to select **mono**, **stereo** or **SAP(secondary audio program)**.

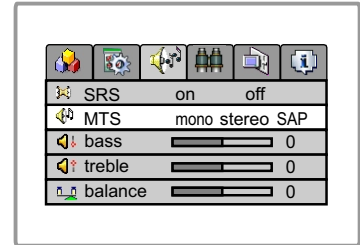

You can also directly press **STEREO** button on the remote control to select the MTS. The MTS mode changes as follows:

MONO ↔ STEREO (If the program is **STEREO**)

MONO ↔ SAP (If the program is **SAP**)

MONO → STEREO → SAP (If the program is **STEREO & SAP**)



NOTE: SAP = Secondary Audio Program.

Adjusting volume

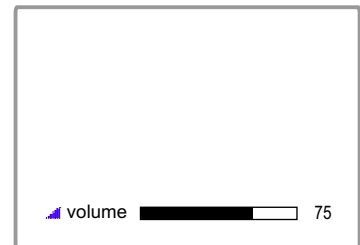
Press **VOL+/-** to adjust volume. Press **VOL+** button, the volume increases. Press **VOL-** button, the volume decreases. (Range:0-100)



Muting the sound

You can press the  button on the remote control to mute the sound. Press the  button again to restore. You can also press **VOL+** to restore the sound.

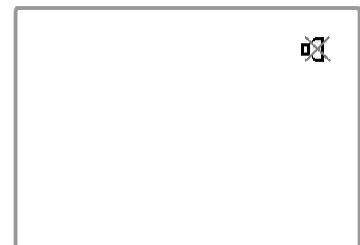

Selecting the sound mode

You can press **S.M** button on the remote control to switch the sound mode between **user**, **movie**, **music**, and **news**.

Movie: Select for a movie program.

Music: Select for a music program.

News: Select for a speech or talk program.

Custom settings mode in the Audio Setting OSD are saved under **USER** mode.

Operations (continued)

Audio Setting

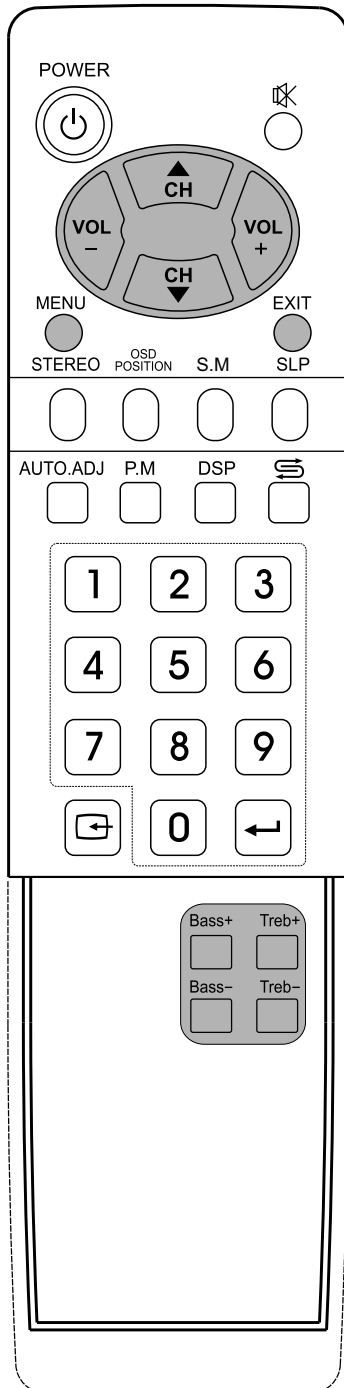

Adjusting the bass/treble

- 1 Access the **Audio Setting** menu.
- 2 Press **CH** ▲/▼ to select **bass** or **treble** item.
- 3 Press **VOL** +/- to adjust the bass or treble.

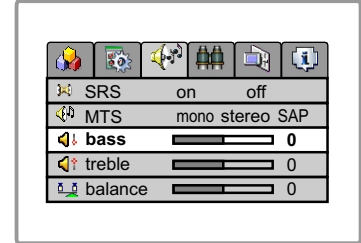

You can press the **Bass** +/- buttons on the remote control to adjust the **bass** directly; and you can also press the **Treb** +/- buttons on the remote control to adjust the **treble** directly.

Adjusting the sound balance

- 1 Access the **Audio Setting** menu.
- 2 Press **CH** ▲/▼ to select **balance** item.
- 3 Press **VOL** +/- to adjust the balance of the left track and right track.

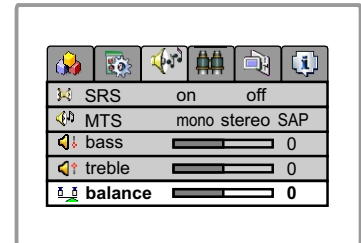

Adjusting the SRS

- 1 Access the **Audio Setting** menu.
- 2 Press **CH** ▲/▼ to select **SRS** item.
- 3 Press **VOL** +/- to select **on** or **off**.

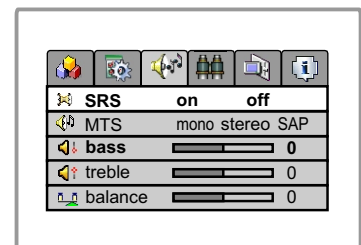

SRS (Sound Retrieval System®) is an audio enhancement technology that restores the spatial cues that are present in a live listening environment and processes it to provide a natural 3D sound field.

* The SRS symbol is a trademark of SRS Labs, Inc.
SRS technology is incorporated under license from SRS Labs, Inc.

Operations (continued)

Channel Setting

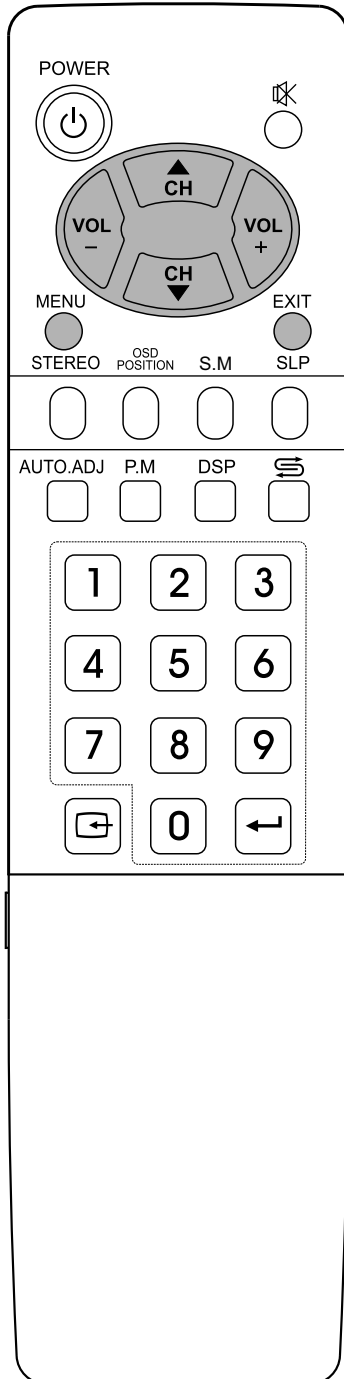

Selecting antenna/cable

- 1 Access **Channel Setting** menu.
- 2 Press **CH ▲/▼** to select **antenna/cable** item.
- 3 Press **VOL+/-** button to select **antenna** or **cable**.

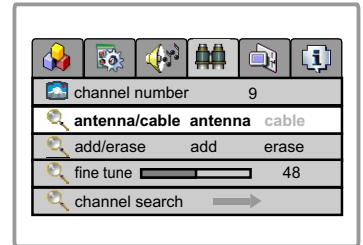

Please select **antenna** or **cable** before you start **Auto Search**. If the TV is connected to antenna, please select **antenna**. If the TV is connected to cable, please select **cable**.

Auto Search

Please access the **Channel Setting** menu first.

- 1 In Channel Setting menu, press **CH ▲/▼** button repeatedly to highlight **channel search** item.
- 2 Press **VOL+/-** to start Auto Search.
All active channels will be preset and stored into the memory automatically.

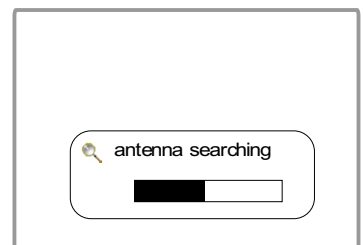
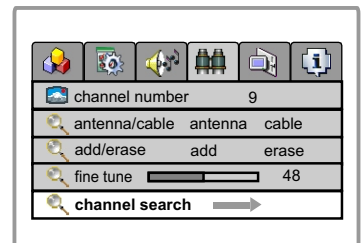

Operations (continued)

Channel Setting

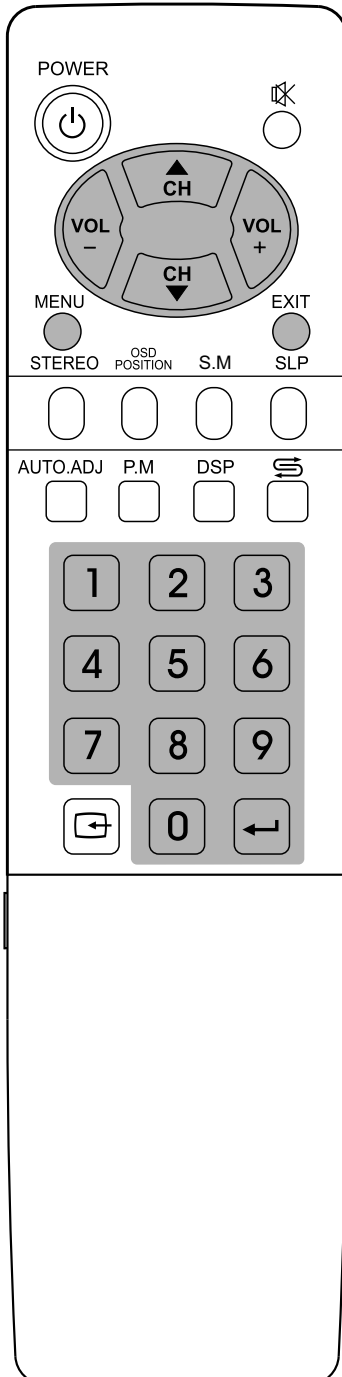

Adding/Erasing Channels

After the Channel SEARCH, you can **Add/Eraser** channels that you watch when you press the **CH▲/▼** to change channels.

1 Select the channel number which you want to erase using the keypad.

2 Access the **Channel Setting** menu.

3 Press **CH▲/▼** to select **add/erase** item.

4 Press **VOL+/-** to select **erase**. When you press **CH▲/▼** to change channels, this channel will be skipped.

If you want to resume a skipped channel, use the keypad buttons to enter the channel, then access the **Channel Setting** menu, press **VOL+/-** to select **add**. When you press **CH▲/▼** to change channels, the

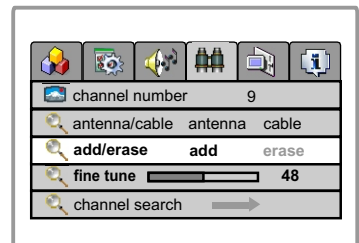
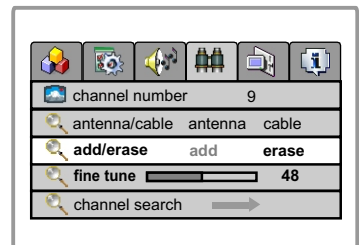

Fine tuning

Please access the **Channel Setting** menu first.

1 In **Channel Setting** menu, press **CH▲/▼** button repeatedly to highlight **Fine tune** item.

2 Press **VOL+/-** to fine tune to achieve best picture and sound.

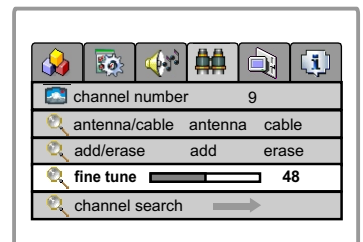

Operations (continued)

Selecting channel

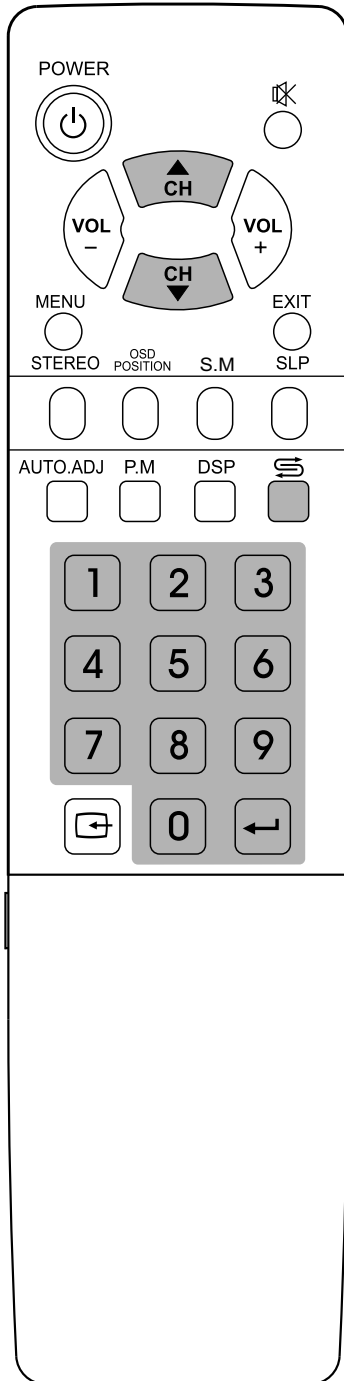

* You can press **DSP** button to Know current channel number information.

Using Keypad buttons

1 To select one-digit channel numbers:

Input the channel using the **0-9 number button**, then press **Channel Enter** ← button to confirm.

2 To select two-digit channel numbers:

Input the channel using the **0-9 number button**, then press **Channel Enter** ← button to confirm.

3 To select three-digit channel numbers:

Input the channel using the **0-9 number button** directly.

Note: Press number buttons within 2 seconds of each other.

Using Channel up/down buttons

1 Press **CH ▲** button, the channel number increases;

2 Press **CH ▼** button, the channel number decreases.

NOTE: This feature works after a channel search is complete.

Using previous channel button

Press **↔** button to switch between the current channel and previous channel.

Operations (continued)

OSD Setting

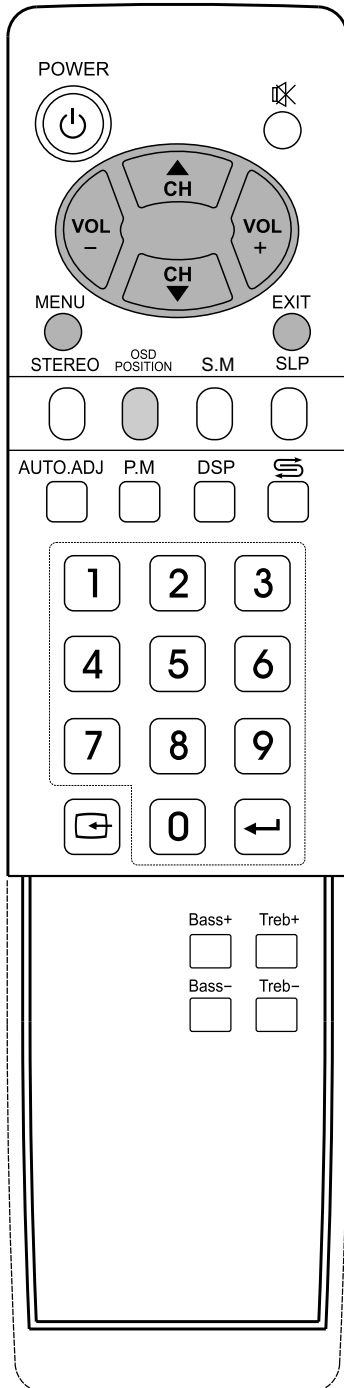

Setting the language of the menu

- 1 Access the **OSD Setting** menu.
- 2 Press **CH ▲/▼** to select the **language** item.
- 3 Press **VOL+/-** to select an OSD language. English, Spanish and French can be selected.

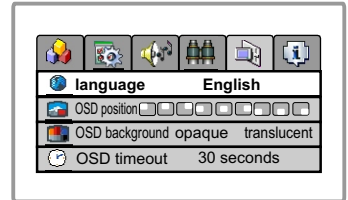

Setting the position of the menu

- 1 Access the **OSD Setting** menu.
- 2 Press **CH ▲/▼** to select the **OSD position** item.
- 3 Press **VOL+/-** to select the position of the menu displaying.

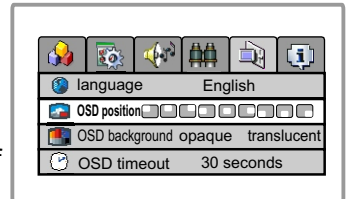

You can also press the **OSD POSITION** button on the remote control to select OSD menu position.

Setting the background of the menu

- 1 Access the **OSD Setting** menu.
- 2 Press **CH ▲/▼** to select the **OSD background** item.
- 3 Press **VOL+/-** to select **opaque** or **translucent**. If you select Opaque, the background of the menu is opaque. If you select translucent, the background of the menu is translucent.

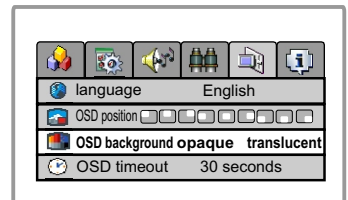

Setting the OSD timeout

- 1 Access the **OSD Setting** menu.
- 2 Press **CH ▲/▼** to select the **OSD timeout** item.
- 3 Press **VOL+/-** to set the timeout: 5, 10, 15, 20, 25, 30, 35, 40, 45, 50, 55, 60 seconds.

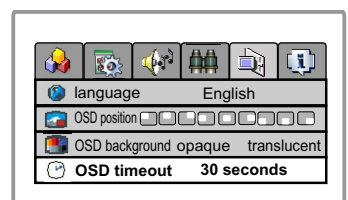

Operations (continued)

Timer setting

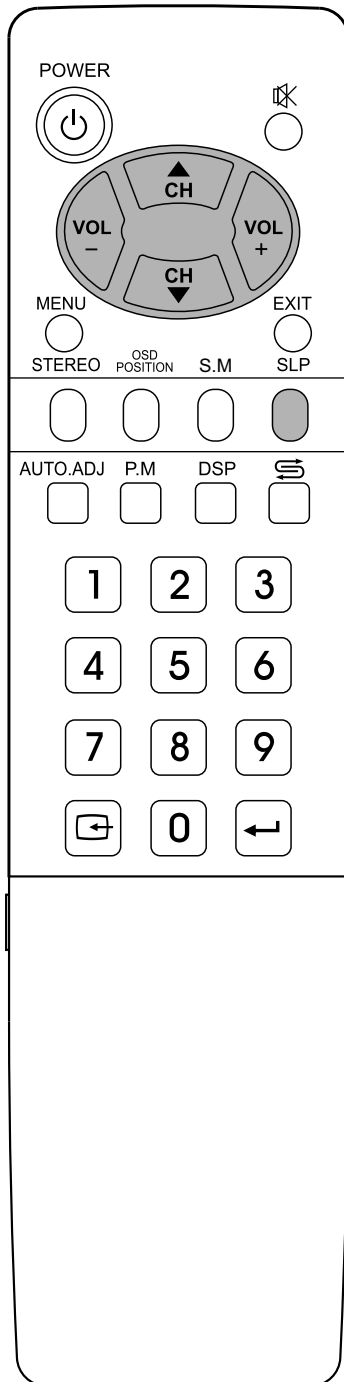

Using Sleep button

Press **SLP** button to display **sleep timer** menu. Press **CH▲/▼** or **VOL+/-** repeatedly to set sleep time between:0, 10, 20, 30, 60, 90, 120, 180, 240 minutes. If you select 0 minute, the sleep timer function is turned off.

Press the **SLP** button again to exit the menu.

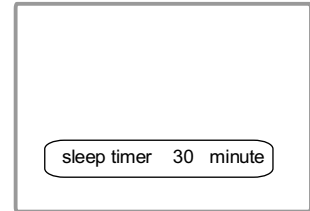

Operations in VGA /YPbPr mode

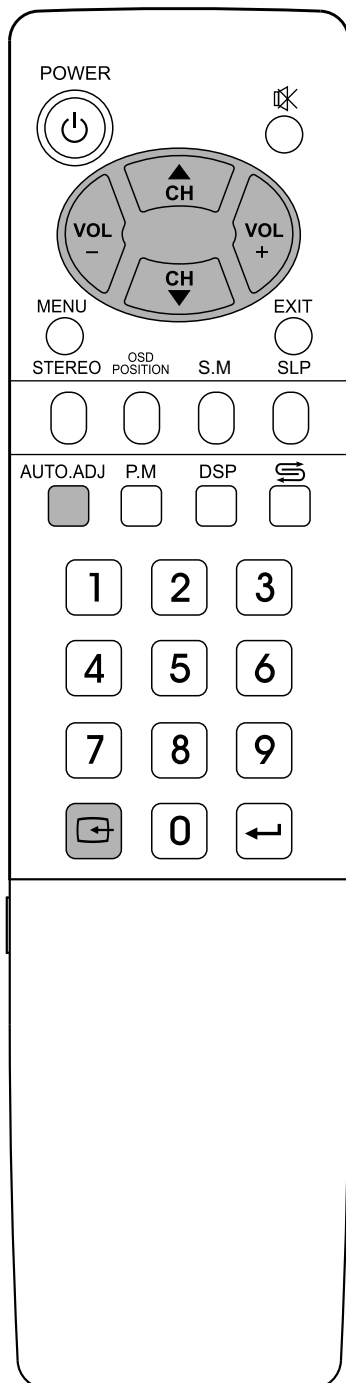

Select VGA/YPbPr mode

- 1 Press the **SOURCE** button on the unit or button  on the remote control. The screen displays the menu shown as right.
- 2 Press **CH ▲/▼** to highlight the **VGA** or **YPbPr/YCbCr** item. Press **VOL+/-** or wait about 4 seconds and the signal source is selected.

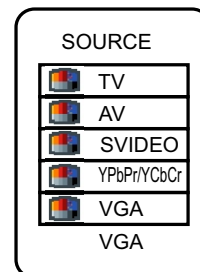

PC signal format

Connect VGA input and be sure that there is VGA input signal. The signal format should be set to: 1024 x 768@60Hz.

! Note:

The resolution of the LCD panel is 1024 x 768; any higher Resolution output from your PC Video card might distort the image.

Auto adjusting

When VGA signal format is changed or when you switch to VGA mode from another source, the unit adjusts frequency and phase automatically to obtain the best display. During the process of auto correction, the screen displays **Analog RGB Acquiring Signal**, and all buttons on the set and on the remote control do not work until this process is finished.

When the set displays some nonstandard VGA signals and can not adjust the picture to the best status by itself, you can adjust it again by pressing the **AUTO. ADJ** button on the remote control.

NOTE: Please note your final phase and frequency settings as you might need to re-adjust your screen.

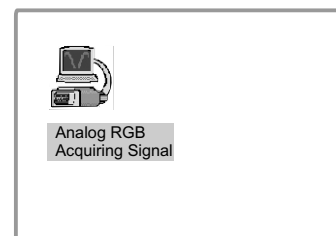

Operations in VGA /YPbPr mode (continued)

Picture Settings

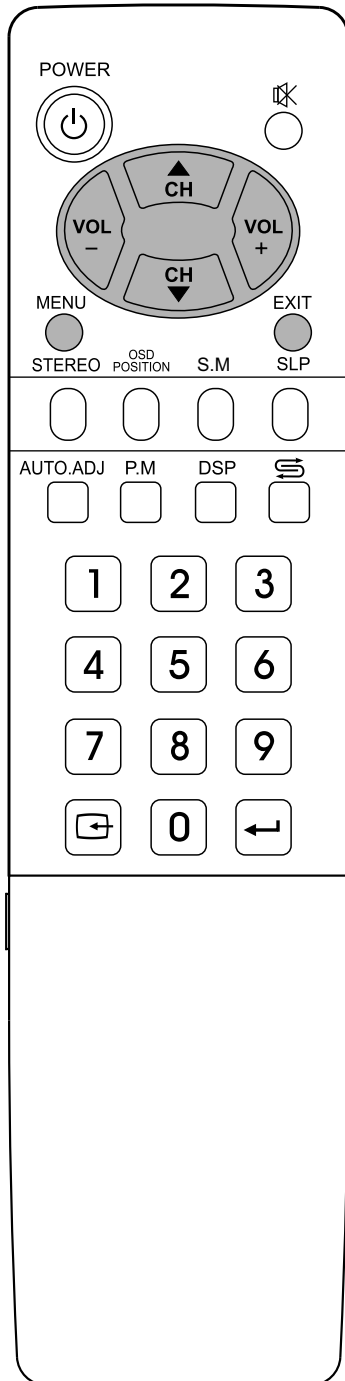

Adjusting Brightness/Contrast

- 1 Access the **PICTURE** menu.
- 2 Press **CH ▲/▼** to select **brightness** or **contrast** item.
- 3 Press **VOL+/-** to adjust the selected item.

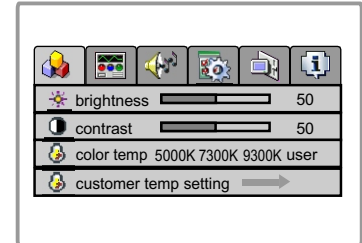

Item	Function	Notes
brightness	Adjust the brightness of the picture.	Adjusting the picture under VGA mode will not affect the display settings in the TV, AV mode.
contrast	Adjust the contrast of the picture.	

Setting the color temperature

- 1 Access the **Picture Setting** menu.
- 2 Press **CH ▲/▼** to select **color temp** item.
- 3 Press **VOL+/-** to switch the color temperature between 5000K, 7300K, 9300K and User.
- 4 If you want to change the value of the user mode, set **color temp** to **user** first, then select **customer temp setting** item, and press **VOL+/-** to access the sub-menu.
- 5 Press **CH ▲/▼** to select the item and press **VOL+/-** to adjust it. The value you set will be stored .

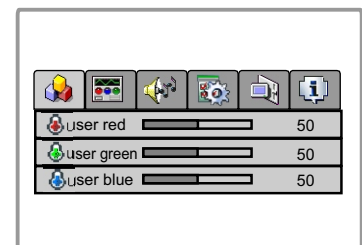
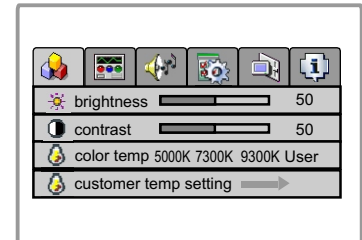

Troubleshooting

Before calling for repair service, check the following items for possible remedies to an encountered symptom.

Symptoms	Check item
Ghost or double images	✍ This may be caused by obstruction to the antenna due to high rise buildings or hills. Using a highly directional antenna may improve the picture.
No power	✍ Check that the AC power cord is plugged into the mains socket. ✍ Unplug the power cord, wait for 60 seconds. Then re-insert plug into the mains socket and turn on the unit again.
No picture	✍ Check antenna connections at the rear of the unit to see if it is properly connected to the unit. ✍ Possible broadcast station trouble. Try another channel. ✍ Adjust the contrast and brightness settings. ✍ Check the Closed Captions control. Some TEXT modes could block the screen. ✍ Select a correct input. ✍ Is a non-compatible signal being input?
Good picture but no sound	✍ Increase the VOLUME. ✍ Check that the unit is not muted. ✍ Check whether headphones are connected.
Good sound but poor color	✍ Adjust the contrast, color and brightness settings.
Poor picture	✍ Sometime poor picture quality occurs when an S-VHS camera or camcorder is connected while another peripheral is connected at the same time. In this case, switch off one of the peripherals. ✍ Check whether the room is too bright
Horizontal dotted line	✍ This may be caused by electrical interference (e.g. hairdryer, nearby neon lights, etc.) ✍ Turn off the equipment which produces the interference.
Television not responding to remote control	✍ Check whether the batteries are working. Replace if necessary. ✍ Clean the remote control sensor lens on the unit. ✍ Do not use the remote control under strong or fluorescent lighting. ✍ The batteries should be inserted with polarity (+, -) aligned.
Snowy picture and noise	✍ Check the antenna connection.
Unstable or not synchronized VGA picture	✍ Check if you have selected the correct VGA mode in your PC.
No output from one of the speakers	✍ Adjust Sound Balance.
Control buttons do not work.	• Unplug the power cord, wait for a few seconds. Then plug the power cord in again and turn on the unit back on.

Note:

If your problem is not solved, restart your TV by turning it off and then on again once. Never attempt to repair any TV yourself.

Specifications

Power supply for AC adapter:	~ 100-240V, 50/60Hz
Power Consumption:	48W (Max.)
Resolution:	1024 x 768
Pixel Pitch:	0.297mm x 0.297mm
Brightness:	500 nit
Contrast:	500:1
Viewing angle:	120°(H)/100°(V)
Dimensions :	18.5 (W) x 7.09 (D) x 12.76(H) (inch)
Weight:	8.8 lb
Screen:	15"

TV system & channel coverage:

SYSTEM	VHF	UHF	CATV
NTSC-M	2-13	14-69	1-125

Color system: NTSC

Speaker : 3W, 8Ω x 2

Accessories: Operating manual x1, Power cord x 1,
Remote control x 1,
AAA batteries x 2, AC Adapter x 1
AV cable x 1(option),
Audio cable x 1(option),
VGA Cable (15 pin D-Sub) x 1(option)

For service, support and warranty information, visit www.pwwservice.com or call 1-866-396-6322.

"Polaroid" is a registered trademark of Polaroid Corporation of Waltham, MA USA and licensed for use on the FLM-1511 to Petters Consumer Brands, LLC.



**PRINTED IN
RECYCLED PAPER**

604-L15H36-00