



Your TV may look different from the one pictured above.

Questions? Need some help?

This manual should help you understand your new product. If you have questions, call our free-phone number found on the insert with this icon:



Or visit www.polaroid.com.

©2007 by  Polaroid All rights reserved.

“Polaroid” and “Polaroid and Pixel” are trademarks of Polaroid Corporation. Changes are periodically made to this document. Changes, technical inaccuracies, and typographic errors will be corrected in subsequent editions.

For service, support and warranty information, visit www.polaroid.com.



This product contains electrical or electronic materials. The presence of these materials may, if not disposed of properly, have potential adverse effects on the environment and human health. Presence of this label on the product means it should not be disposed of as unsorted waste and must be collected separately. As a consumer, you are responsible for ensuring that this product is disposed of properly. To find out how to properly dispose of this product, please go to www.polaroid.com and click on “Company” or call the customer service number for your country listed in the instruction manual.

HDMI™

This TV incorporates High-Definition Multimedia Interface (HDMI™) technology. HDMI, the HDMI logo and High-Definition Multimedia Interface are trademarks or registered trademarks of HDMI Licensing LLC.

Warnings and Precautions

To prevent any injuries, the following safety precautions should be observed in the installation, use, servicing and maintenance of this equipment.

Before operating this equipment, please read this manual completely, and keep it nearby for future reference.

ENGLISH



This symbol is intended to alert the user to avoid the risk of electric shock. This equipment must not be disassembled by anyone except qualified service personnel.



This symbol is intended to alert the user to the presence of important operating and maintenance instructions in the literature accompanying the appliance.



To reduce the risk of fire or electric shock, do not expose this equipment to rain or moisture.

- TO REDUCE THE RISK OF ELECTRIC SHOCK,
- DO NOT REMOVE COVER (OR BACK).
- NO USER-SERVICEABLE PARTS INSIDE.
- REFER SERVICING TO QUALIFIED SERVICE PERSONNEL.



Use of controls, adjustments or performance of procedures other than those specified herein may result in hazardous radiation exposure.

Important Safety Instructions



This symbol indicates caution points.



This symbol indicates actions that should not be done.



This symbol indicates actions that must be performed.



- Do not place the equipment on any uneven or unstable carts, stands, tables, shelves etc. The equipment may fall, causing serious injury to children or adults and serious damage to the equipment itself.



- Use only a cart or stand recommended by the manufacturer. This equipment and recommended cart or stand should be handled with care. Quick stops, excessive force, and uneven surfaces may cause the equipment and cart/stand to overturn.



- Do not disable the 3-wire grounding type plug. The grounding pin on the 3-prong plug is an important feature. Removing the grounding pin will increase the risk of damaging the equipment.
- If you can not fit the plug into the electrical outlet, contact an electrician to install a grounding outlet.
- Always operate this equipment from the type of power source indicated on the rear of the serial/model information label.
- Never overload wall outlets and extensions.



- Use and handle the power cord with care. Do not place any heavy objects on the AC power cord.
- Do not pull the AC power cord. Do not handle the AC power cord with wet hands.
- Do not touch the power cord and antenna cable during lightning.
- Remove the plug from the wall outlet if the equipment will not be used for a long period of time.
- Do not place, use or handle this equipment near water.
- Never expose the equipment to liquid, rain, or moisture. Seek advice if any liquid is spilt into the equipment.
- Do not expose the equipment to extreme temperature or to direct sunlight, as the equipment may overheat and suffer damage.
- Do not install the equipment near any heat sources such as radiators, heat registers, stoves, or any other apparatus that might produce heat.
- Do not attempt to service the equipment yourself.
- Opening and removing the covers may expose you to dangerous voltage or other hazards and may void your warranty. Refer service to qualified personnel.
- Do not place or drop any other objects on top.
- Do not insert anything into the ventilation holes of your equipment. Inserting any metal or flammable objects may result in fire or electric shock.
- Do not place the equipment on uneven or unstable carts, stands, tables, shelves etc. The equipment may fall, causing serious injury to children or adults and serious damage to the equipment itself. Always place the equipment on the floor or on a surface that is sturdy, level, stable and strong enough to support the weight of the equipment.
- Do not block any ventilating openings. Leave an open space around the equipment. Never place the equipment :
on a bed, sofa, rug, or any other similar surfaces; too close to drapes/curtains/walls, in a bookcase, built-in cabinet, or any other similar places that may cause poor ventilation.
- Unplug this apparatus during lightning storms or when unused for long periods of time.
- Refer all servicing to qualified service personnel. Servicing is required when the apparatus has been damaged in any way, such as power-supply cord or plug is damaged, liquid has been spilled or objects have fallen into the apparatus, the apparatus has been exposed to rain or moisture, does not operate normally, or has been dropped.



- Always remove the power cord from the outlet before cleaning the equipment.
- Never use liquid or aerosol cleaners on the equipment. Clean only with a soft dry cloth.



- Only use attachments/accessories specified by the manufacturer.

Antenna Safety Instructions

If an outdoor antenna is connected, follow the precautions below:



- An outdoor antenna should not be located in any area where it could come in contact with overhead power lines, or any other electric light or power circuits.
- When installing an outdoor antenna system, extreme caution should be taken to prevent contact with power lines. Direct contact with power lines may be fatal and should be avoided at all costs.

ENGLISH

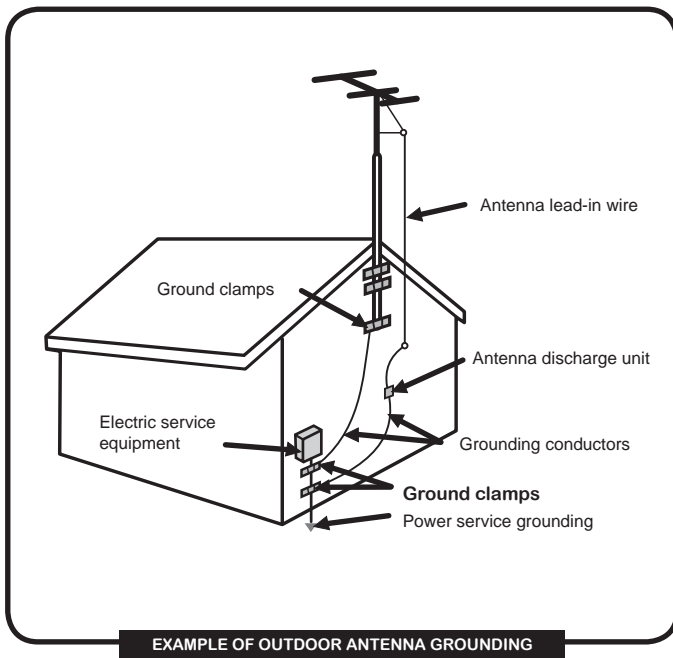

CONTENTS

■ Warnings and Precautions

Important Safety Instructions	1
Antenna Safety Instructions.....	3

■ Chapter 1 INTRODUCING THE LCD TV

Key Features	5
Cleaning Your LCD TV	5
Package Contents	6
Setting Your LCD TV.....	7
Your LCD TV	9
Your Remote Control	11

■ Chapter 2 INSTALLING THE LCD TV

Connecting a TV Cable or an Antenna	13
Connecting an A/V Device with Composite Connector.....	20
Connecting an A/V Device with S-Video Connector	21
Connecting an A/V Device with Component (YPbPr) Connector.....	22
Connecting an A/V Device with SCART Connector.....	23
Connecting an AV Device with HDMI Connector	24
Connecting an AV Device with DVI Connector	25
Connecting a PC.....	26
Connecting an Audio Receiver or a Digital System	27

■ Chapter 3 USING THE FEATURES

Operating the Menu.....	28
Customizing the Picture Settings	30
Customizing the AUDIO Settings	32
Customizing the OSD SETUP Settings.....	33
Customizing the TV Settings	34
Customizing the VGA Settings.....	36

■ Chapter 4 USING THE DTV FEATURES

Operating the Menu.....	38
Customizing the Channel List Settings.....	40
Customizing the Configuration Settings	42
Customizing the Parental Control Settings	44
Using the DTV OSD Settings	45

■ Troubleshooting..... 46

■ Specifications

47

Chapter 1

Introducing the LCD TV

Key Features

ENGLISH

Various Audio/Video terminals for external equipment connection

- 1 composite video input terminal
- 1 S-VIDEO terminal
- 1 SCART input terminal
- 1 set of component Video input terminals
- 1 PC VGA IN terminal
- 1 PC AUDIO IN terminal
- 1 HDMI IN input terminal
- 1 set of Audio(L/R) output terminals for composite C-VIDEO/S-VIDEO
- 1 Digital output terminal
- 1 Headphone terminal

High Definition Multimedia Interface (HDMI)

- High Definition Multimedia Interface (HDMI) is a small, user-friendly interconnect that can carry up to 5 Gbps of combined video and audio in a single cable. This system eliminates the cost, complexity and confusion of multiple cables used to connect current A/V systems.

HDTV Component Video Inputs

- Offers the best video quality for DVD(480p) and digital set-top-box (HD1080i, 720p) connections.

2D Digital Noise Reduction

- This function can digitally reduce image noise to provide better picture quality.

Film-Mode Detection

- This function can automatically detect content derived from film and adjust the interlacer's frame matching to provide a more natural-looking, clearer image of the moving picture.

Digital Tuner

- The UK is Going Digital!
Find out if you have a digital signal or when it will be available by visiting: <http://www.digitaluk.co.uk/>.

Cleaning Your LCD TV



There are no parts which can be serviced or cleaned inside the TV's cabinet.

You can increase the life of your LCD display by taking the following precautions:

- Before cleaning, always disconnect the power line and all connection cables.
- Do not use any solvents, caustic or gaseous cleaning agents.
- Clean the display with a soft, lint-free cloth.
- Ensure that no water droplets remain on the screen. Water can cause permanent discolouration.

Package Contents

Make sure all of the following contents are included.

- LCD TV



- Remote Control/
AAA Batteries x 2

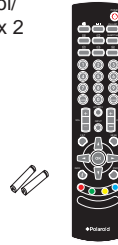

- Video Cable



- Component Cable

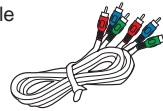

- Power Cord



- Audio Cable

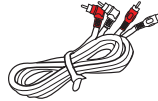

The power cord type may be different depending on your country's power type.

- Quick Guide

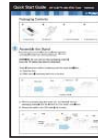

- User Guide



- Warranty Card



These items are all you need to set up and operate the LCD TV in its basic configuration.



Make sure all of the above contents are included. If you are missing any items, please contact Polaroid customer service using the Worldwide Contact Sheet or by visiting polaroid.com.

Setting Up Your LCD TV

How to install the TV Stand

Follow the instructions below to install the TV stand:

- 1 Open the box, and make sure all necessary parts are in the box. The package contains:

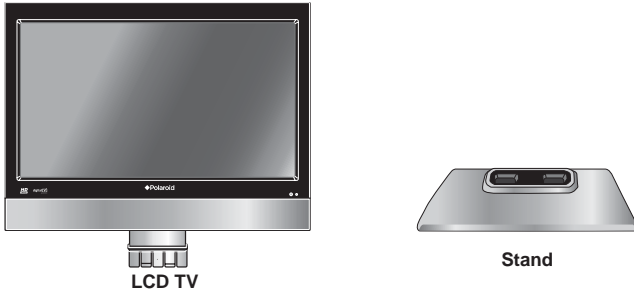

- 2 Cover an even stable surface with a soft cloth. Place the LCD TV unit face-down on the cloth. Fit the stand onto the bottom of the LCD TV unit as shown:

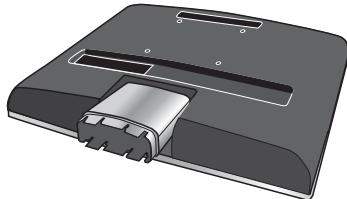

- 3 Then push until stand clicks into the LCD TV's stand socket.

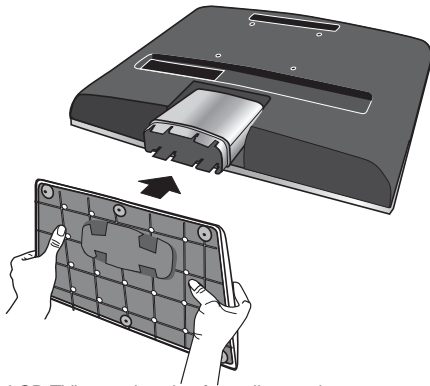

To Remove the LCD TV's stand socket for wall mounting:

Ensure the stand base is removed. For wall mounting the stand socket attached to the back of the TV should be detached. Using a Phillips screwdriver remove the screw which is inside the stand socket. The stand socket section should then slide off the locator rod connected to the TV. To attach this LCD TV to a wall a standard 100x100 VESA mounting bracket is required.

How to setup the TV

- 1 Use an antenna cable to connect the VHF/UHF signal to the LCD TV's ANT. terminal (refer to page 15-18).
- 2 Connect the AC power cord at the back of the TV and connect the power cord to wall outlet.
- 3 Insert the 2 batteries supplied in remote control.

Step1 Slide the back cover up to open the battery compartment of the remote control.

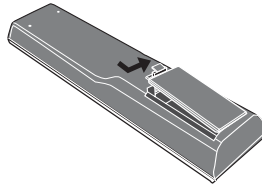

Step2 Insert two AAA size batteries. Make sure to match the (+) and (-) ends of the batteries with the (+) and (-) ends indicated in the battery compartment. Slide the cover back into place.

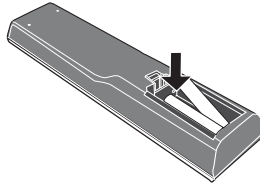

Do not use caustic cleaners (porcelain, stainless steel, toilet, or oven cleaner etc.) on the remote, as it may suffer damage.

- 4 Connect another external AV device (refer to page 19-25).



IMPORTANT: When replacing your used batteries, it is your responsibility as a consumer to ensure the batteries are disposed of properly. To find out how to properly dispose of the batteries, please go to www.polaroid.com and click on "Company" or call the customer service number for your country listed in the instruction manual.

Your LCD TV

Front/Left /Right Side View and Controls

ENGLISH

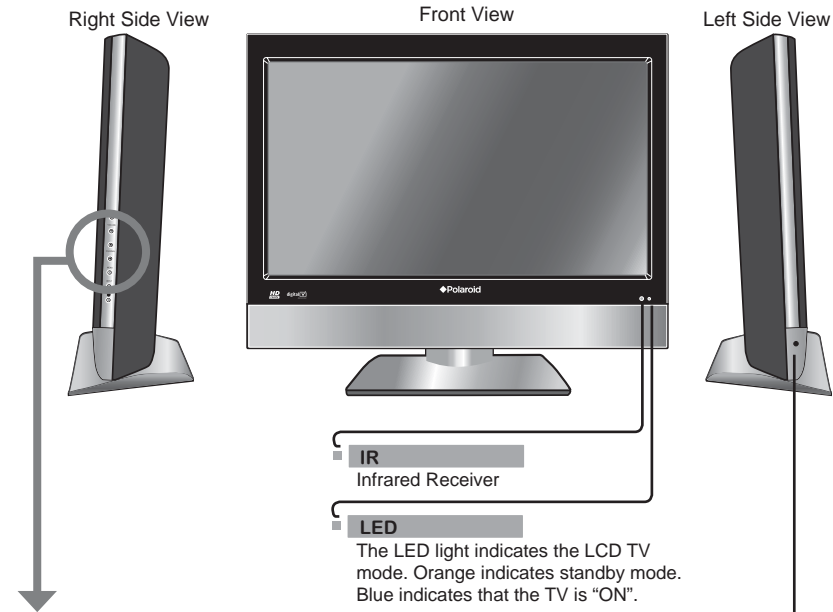

VOLUME+/-
Adjusts the volume up and down.
Selects the main-menu item and change values for items when in the OSD mode.

CHANNEL ▲ ▼
Scans up and down through channels.
Selects sub-menu item when in the OSD mode.

MENU
Press once to display the OSD (on screen display), press again to turn the OSD off.

INPUT
Chooses from different input signal sources.

Power
Turns the LCD TV on and into standby mode.

Rear View and Jacks

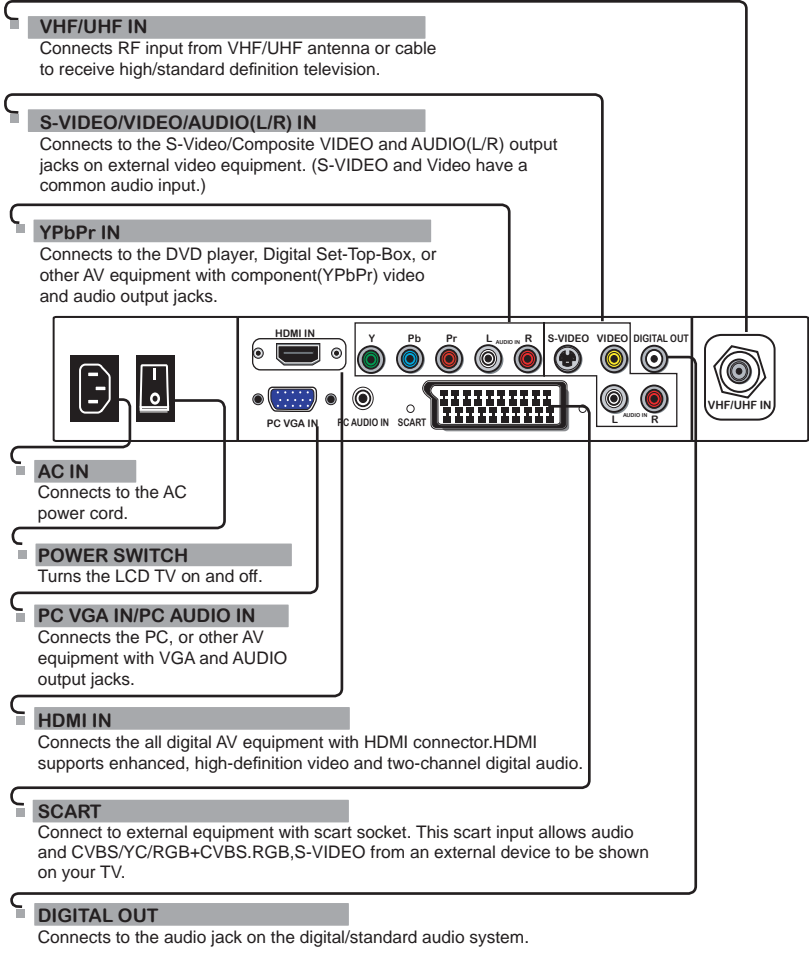



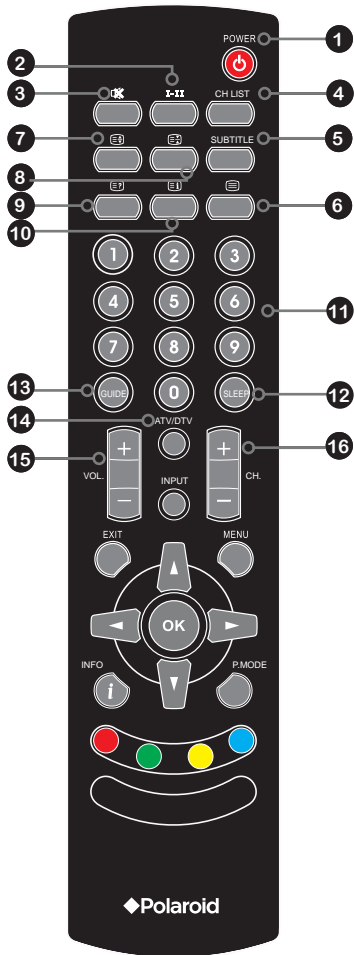

Your Remote Control



- 1 **POWER** Change TV in and out of standby mode
- 2 **I-II** Cycles through the TV sound options (NICAN) : MONO/DUAL/STEREO
- 3  Mutes and restores your LCD TV sound.
- 4 **CH LIST** Display all channel list &name.

Channel list

▶ 1	BBC1
2	BBC2
3	ITV
4	CH4
5	CH5
6	
7	

◀ Move Select ▶ Exit
- 5 **SUBTITLE** Press the SUBTITLE key to display the subtitle which is broadcast with the program on the screen.
- 6  Turns on and off the Teletext function.
- 7  Displays the top, bottom or all of page, to easily read in TELETEXT mode.
- 8  Freezes a multi-page passage on screen in TELETEXT mode.
- 9  Reveals hidden information such as the answer to a quiz in TELETEXT mode.
- 10  Displays the main index in TELETEXT mode.
- 11 **0-9** Pressing a number selects a channel. Following selection, channel activates automatically in 3 seconds.
- 12 **SLEEP** Cycles through the LCD TV sleep time.
- 13 **GUIDE** In DTV mode, pressing GUIDE displays the Electronic Program Guide on the screen
- 14 **ATV/DTV** Pressing enter ATV(analogue) or DTV(digital) mode.
- 15 **VOL.+/-** Increases and decreases volume.
- 16 **CH.+/-** Scans up and down the channels.

ENGLISH

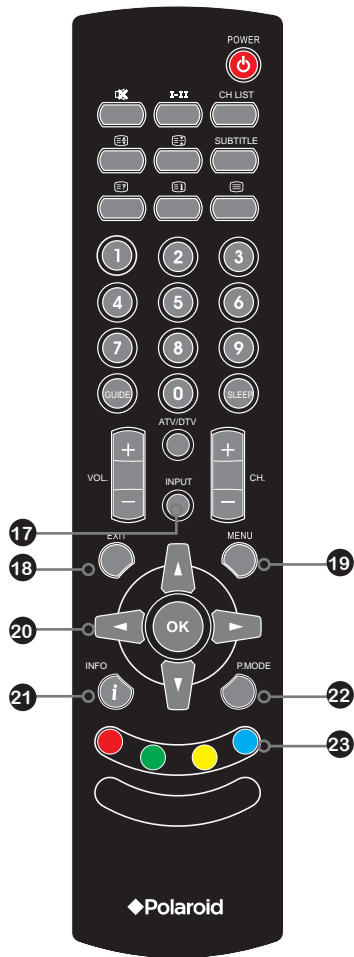

17 INPUT Pressing **INPUT** displays the source list, use ▲▼ to select the video equipment connected to the video inputs of your LCD TV

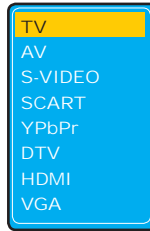

-
- 18 EXIT** Exits the OSD menu.
-
- 19 MENU** Displays the OSD menu on the screen.
-
- 20 ▲▼▶◀ OK** Cycles through OSD options and selects individual menu items. OK confirms option settings.
-
- 21 INFO** Displays information on the LCD TV screen such as input source, channel, program title.
-
- 22 P.MODE** Selects picture mode: Movie/Vivid/Sport/Game/User
-
- 23**  Press the appropriate colour for direct access to the colour page.
-

 **Effective range:**
The remote can control the LCD TV from up to 5m away, if pointed directly at the receiver.

Chapter 2

Installing the LCD TV

Refer to the owner's manual of any external equipment to be connected.
When connecting any external equipment, do not connect any AC power cords to wall outlets until all other connections are completed.

ENGLISH

Connecting a TV Cable or an Antenna

Antenna Connection

The antenna requirements for good color TV reception are more important than those for a black & white TV reception. For this reason, a good quality outdoor antenna is strongly recommended. The following is a brief explanation of the type of connection that is provided with the various antenna systems.

- A 75-ohm system is generally a round cable (not included) with IEC-type connector that can easily be attached to a terminal without tools.

IEC-type connector



75-ohm coaxial cable (round)

- A 300-ohm system is a flat twin-lead cable (not included) that can be attached to a 75-ohm terminal through a 300-75-ohm adapter (not included).



300-ohm twin-lead cable (flat)

Use one of the following two diagrams when connecting an outdoor antenna.

A: Shows how to use a VHF/UHF combination outdoor antenna.

B: Shows how to use a separate VHF and/or UHF outdoor antenna.

A. Combination VHF/UHF antenna

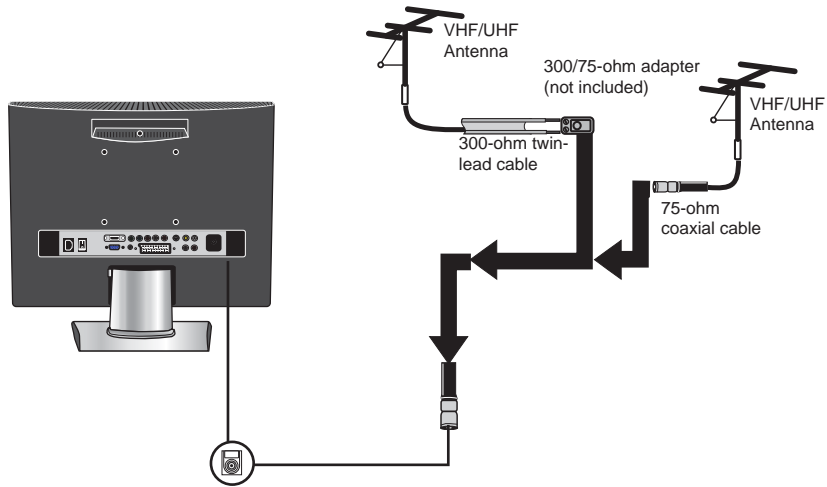

B. Separate VHF and/or UHF antennas

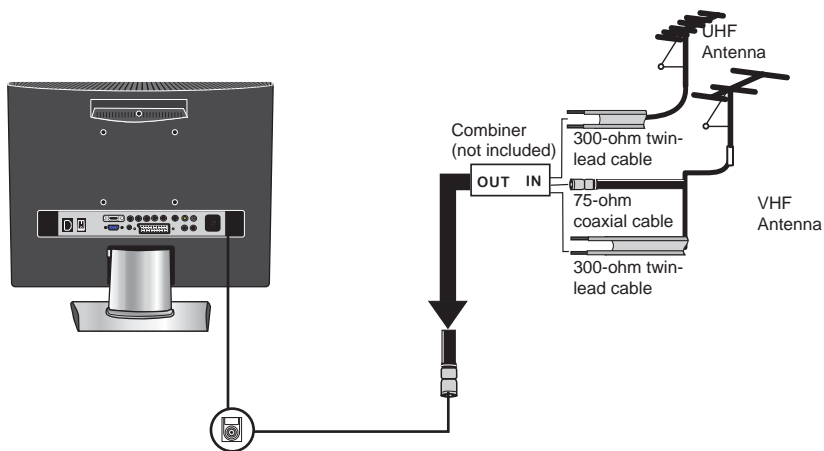

Cable TV (CATV) Connection

- A 75-ohm coaxial cable connector is built into the set for easy hookup. When connecting the 75-ohm coaxial cable to the set, connect the 75-ohm cable into the ANT. terminal.
- Some cable TV companies offer premium pay channels. Since the signals of these premium pay channels are scrambled, a cable TV converter/descrambler is generally provided to the subscriber by the cable TV company.

ENGLISH

This converter/descrambler is necessary for normal viewing of scrambled channels. (Set your TV to channel 3 or 4, typically one of these channels is used. If this is unknown, consult your cable TV company.) For more specific instructions on installing cable TV, consult your cable TV company. One possible method of connecting the converter/descrambler provided by your cable TV company is shown in the diagram below.

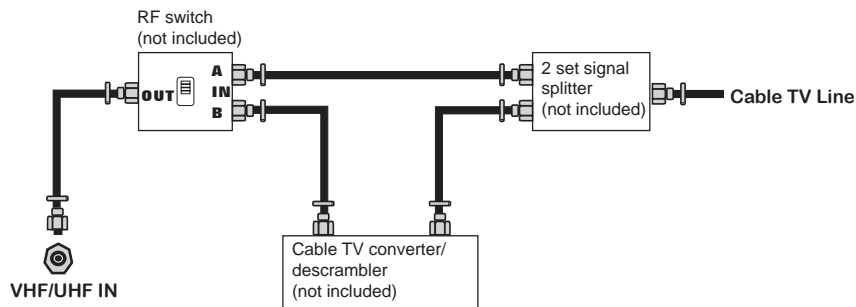

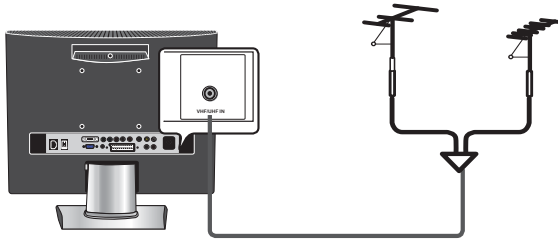

- The RF switch (not included) is required to provide two inputs (A and B). Setting the RF switch to position A allows viewing of all unscrambled channels by using the TV channel keys.
- Setting the RF switch to position B allows viewing of all scrambled channels via the converter/descrambler by using the converter channel keys.

- 1 Use an antenna cable to connect the ATV/DTV signal to the LCD TV's ANT. terminal.

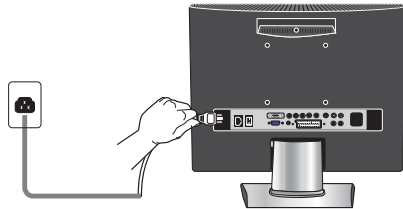

- 2 Connect the AC power cord at the back of the TV and connect the power cord to wall outlet. Turn the POWER SWITCH of rear TV on.



- 3 Press the  button on the remote control to turn on the LCD TV.

 Always disconnect the LCD TV from the power outlet when the LCD TV will not be used for a long period of time. The POWER button on the front panel is only used for switching the LCD TV into standby, it does not disconnect the device from the main voltage. To completely disconnect the main voltage, please remove the power plug from the socket.

- 4 The 1st time installation screen will automatically tune both ATV and DTV signals on initial turn on.
 1. Make sure an aerial is fitted, then press the  symbol OK button on the remote to start the Auto Programme Scan (APS). First ATV will auto tune and auto sort then DTV will automatically follow.

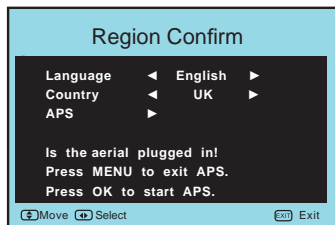

- Use the ▲▼ buttons to select the **YES**. The **Auto Programme Scan (APS)** automatically creates a list of receivable channels. Press the **EXIT** button at any time to interrupt the auto tuning process. (The list cannot be created if interrupted)

ATV MODE



DTV MODE

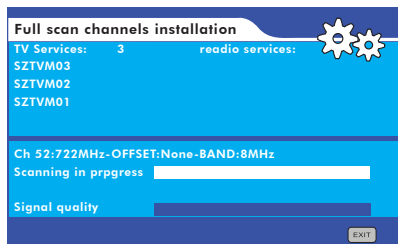

The first time installation is now completed.

ENGLISH

RE-Tuning after initial setup.

1

ATV Mode:

Press the **INPUT** button on the remote to display the Source List. Use the ▲▼ buttons to select **TV**, and press the **OK** button.

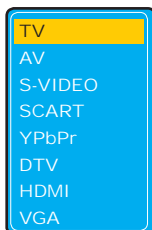

- Press the **MENU** button on the remote control to display the Main menu, and use the ◀▶ buttons to select the **TV**.



2. Press the **▼** button to select **APS** and press the **OK** button to display the Start APS menu:
Select your country by the **◀▶** buttons.



Press the **▼** button to select **APS** and press the **OK** button.

3. Use the **▲▼** buttons to select the **YES**. The **Auto Programme Scan (APS)** automatically creates a list of receivable channels. Press the **EXIT** button at any time to interrupt the tuning process. (The list cannot be created if interrupted)

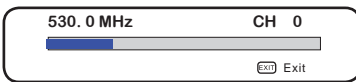

2

DTV Mode:

Press the **INPUT** button on the remote to display the Source List. Use the **▲▼** buttons to select **DTV**, and press the **OK** button.

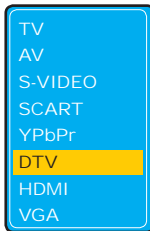

1. Press the **MENU** button on the remote control to display the Main menu, and use the **◀▶** to select the **DTV Services**.

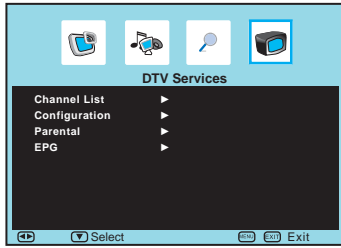

2. Press the **▼** button to select **Configuration** and press the **OK** button to display the Configuration menu:

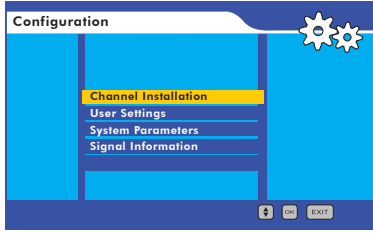

3. Press **▲▼** on the remote control to move the light bar to **Channel Installation** and press the **OK** button to display the Channel Installation menu:

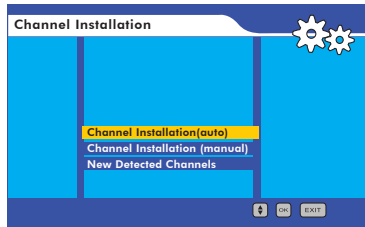

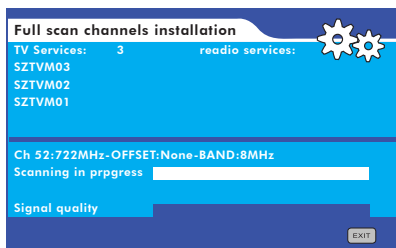

4. Press **▲▼** on the remote control to move the light bar to **Channel Installation (auto)** and press the **OK** button.
5. Press **◀▶** buttons to select **New** from the Installation type.
The Auto Channel Installation automatically creates a list of receivable channels.

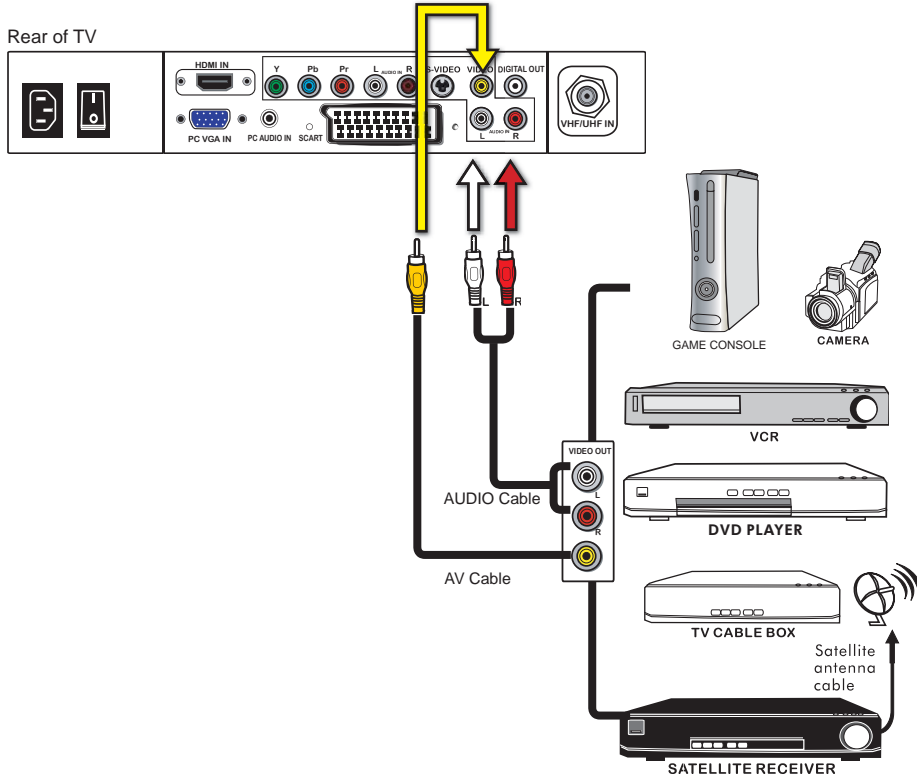

Connecting an A/V Device with Composite Connector





- 1 Use a composite cable to connect the external A/V device's composite video/audio jacks to the LCD TV's VIDEO IN jacks.
- 2 Connect all AC power sources, before turning on the power switch of the LCD TV or other connected equipment.
- 3 Press the  button on the remote to turn on the LCD TV.
- 4 To view the A/V device's with component input, press the **INPUT** button on the remote to select **AV**.

 Not all A/V devices have the ability to connect to a TV. Please check your A/V devices user guide for compatibility.

Connecting an A/V Device with S-Video Connector

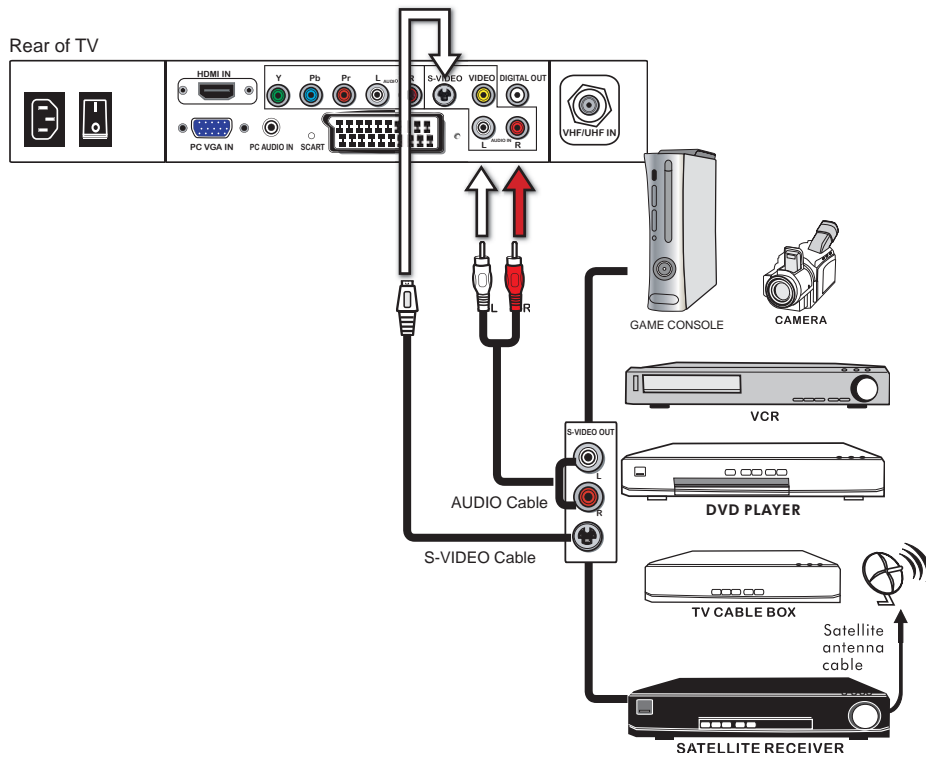
ENGLISH



- 1 Use an audio cable to connect the external A/V device's audio output jacks to the LCD TV's audio inputs. Use a S-Video cable to connect the external A/V device's S-Video output jack to the LCD TV's S-Video IN input jack.
- 2 Connect all AC power sources, before turning on the power switch of the LCD TV or other connected equipment.
- 3 Press the  button on the remote to turn on the LCD TV.
- 4 To view the A/V device's with component input, press the **INPUT** button on the remote repeatedly to select **S-VIDEO**.

Connecting an A/V Device with Component (YPbPr) Connector

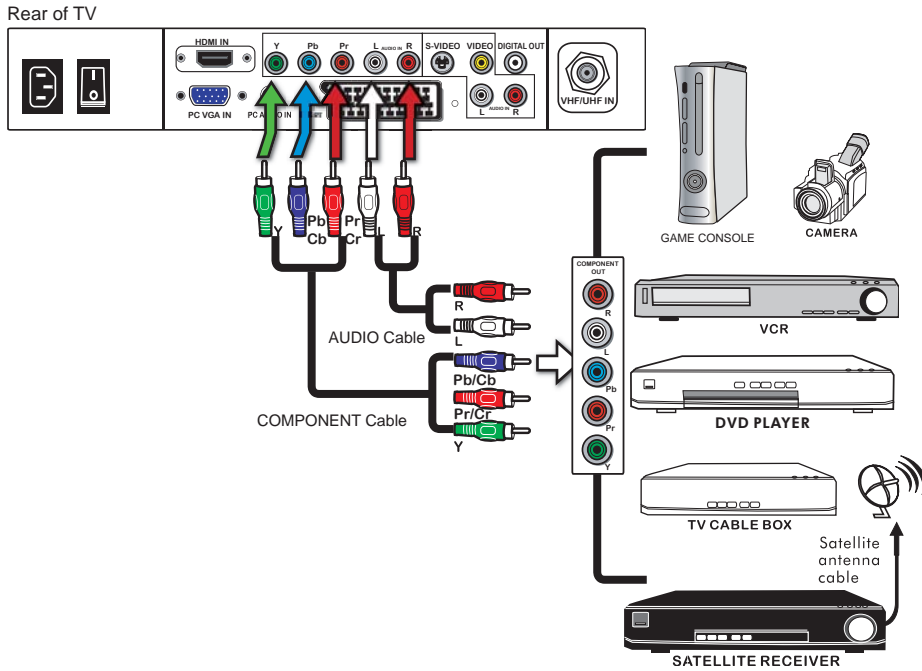

! Not all A/V device have the ability to connect to a TV. Please check your A/V device user guide for compatibility.

- 1** Use a component cable to connect the external A/V device's component output jacks to the LCD TV's YPbPr IN input jacks. Use an audio cable to connect the external A/V device's component audio jacks to the LCD TV's audio input jacks.
- 2** Connect all AC power sources, before turning on the power switch of the LCD TV or other connected equipment.
- 3** Press the **⏻** button on the remote to turn on the LCD TV.
- 4** To view the A/V device's with component input, press the **INPUT** button on the remote repeatedly to select **YPbPr**.

! The component video jacks on your A/V device are sometimes labeled YPbPr, or YCbCr. For an explanation of component video, see your A/V device's user guide.

Connecting an A/V Device with SCART Connector

ENGLISH

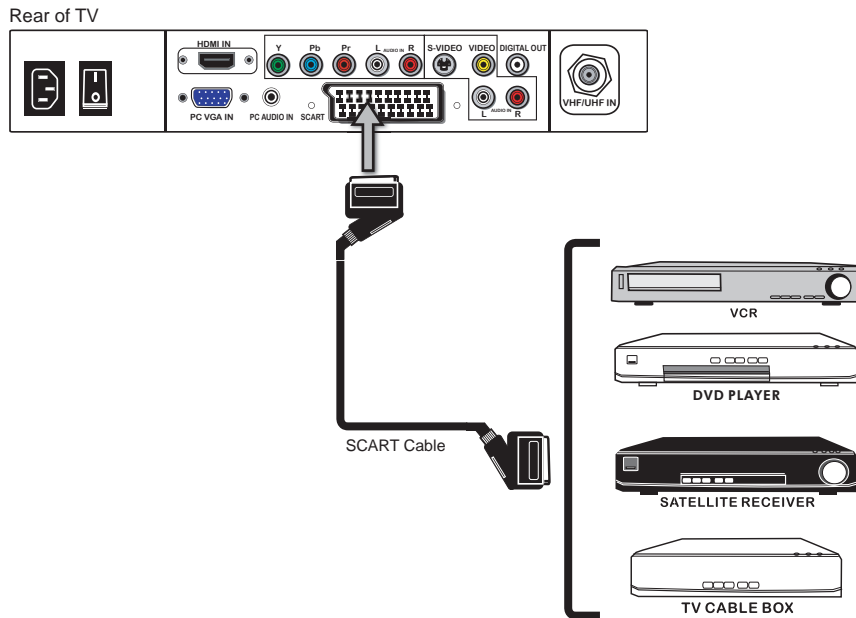

- 1 Use a SCART cable to connect the external A/V device's SCART socket to the LCD TV's SCART IN jack.
- 2 Connect all AC power sources, before turning on the power switch of the LCD TV or other connected equipment.
- 3 Press the  button on the remote to turn on the LCD TV.
- 4 Press the **INPUT** button on the remote to select **SCART**.

Connecting an AV Device with HDMI Connector

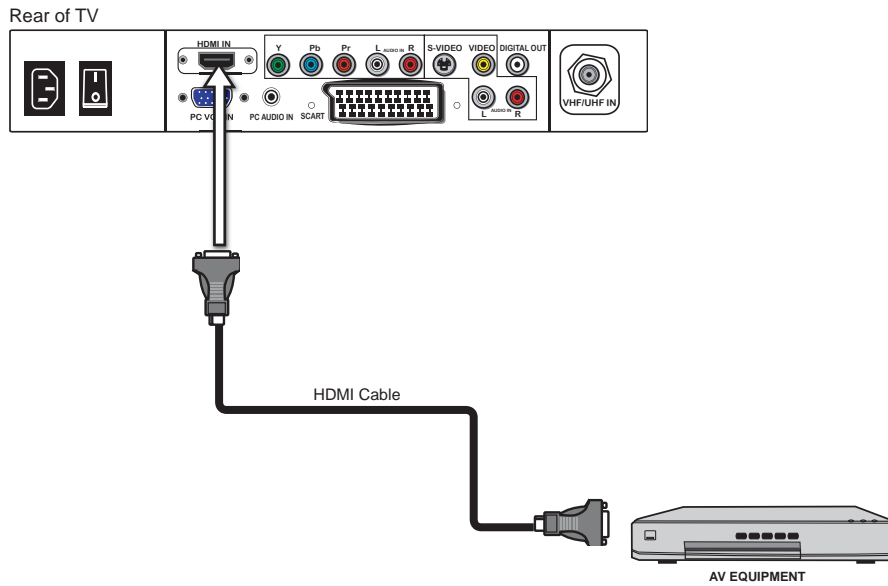



- 1 Use a HDMI cable to connect the AV equipment's HDMI output jack to the LCD TV's HDMI IN jacks.
- 2 Connect all AC power sources, before turning on the power switch of the LCD TV or other connected equipment.
- 3 Press the  button on the remote to turn on the LCD TV.
- 4 Press the **Input** button on the remote to select **HDMI**.

 The HDMI connector provides both video and audio signals, it's not necessary to connect the audio cable.

Connecting an AV Device with DVI Connector

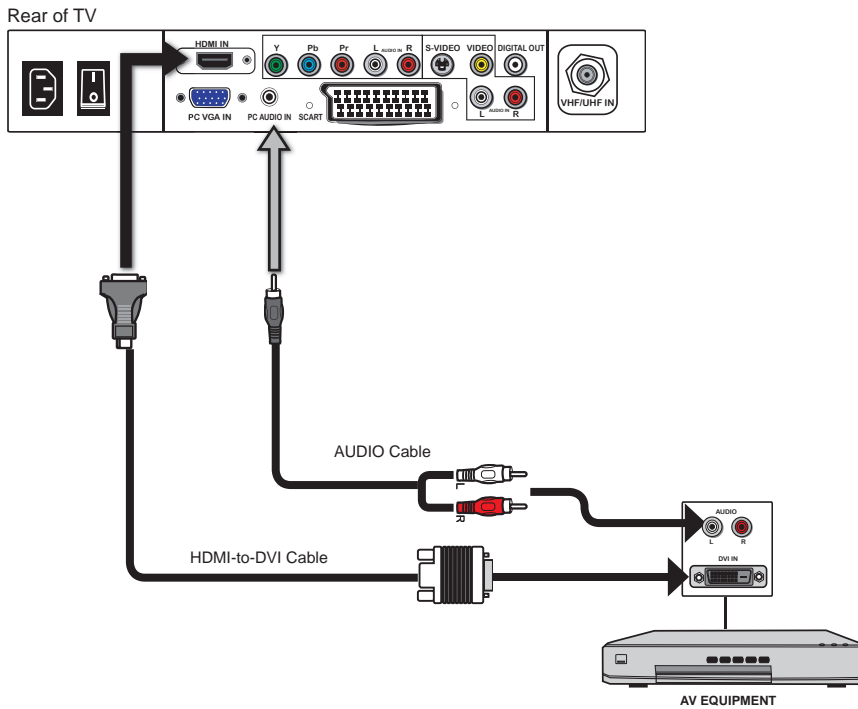
ENGLISH



- 1 Use a HDMI-to-DVI cable to connect the AV equipment's DVI output jack to the LCD TV's HDMI IN jacks.
Use an audio cable to connect the AV equipment's audio output jacks to LCD TV's HDMI AUDIO jacks.
- 2 Connect all AC power sources, before turning on the power switch of the LCD TV or other connected equipment.
- 3 Press the  button on the remote to turn on the LCD TV.
- 4 Press the **Input** button on the remote to select **HDMI**.

 If the LCD TV is connected to AV equipment's DVI connector, you will need an HDMI-to-DVI cable or an HDMI adapter(not supplied) and an audio cable.

Connecting a PC

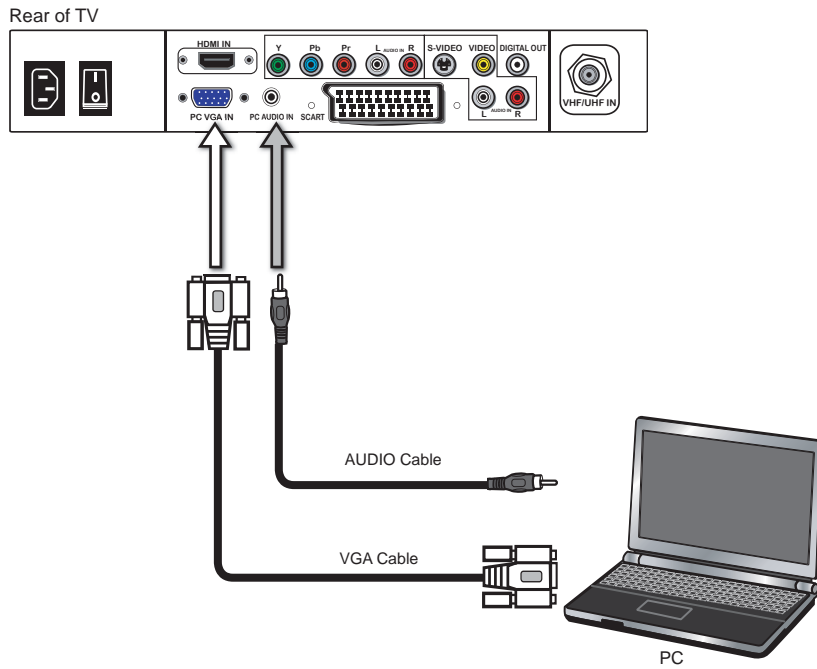

- 1 Use a D-SUB cable to connect the PC's D-SUB output jack to the LCD TV's VGA input jack. Use an audio cable to connect the PC's audio output jacks to LCD TV's.
- 2 Connect all AC power sources, before turning on the power switch of the LCD TV or other connected equipment.
- 3 Press the  button on the remote to turn on the LCD TV.
- 4 Press the **INPUT** button on the remote to select **VGA**.

Connecting an Audio Receiver or a Digital System

For better sound quality, you may want to use a Home Theater/Stereo System.

NOTE: If you have a Home Theater/Stereo System that you would like to use with your new Polaroid TV, we recommend that you do NOT use your TV's audio output for this connection. For the best sound quality, our product testing has shown that you should connect your Home Theater/Stereo System directly to your A/V device. I.E. You should connect your Home Theater/Stereo System to your DVD player, Cable/Satellite box or other AV equipment.

Although not recommended, if you prefer to use the TV audio output to make this connection to your Home Stereo System, please follow the instructions below.

ENGLISH

Rear of TV

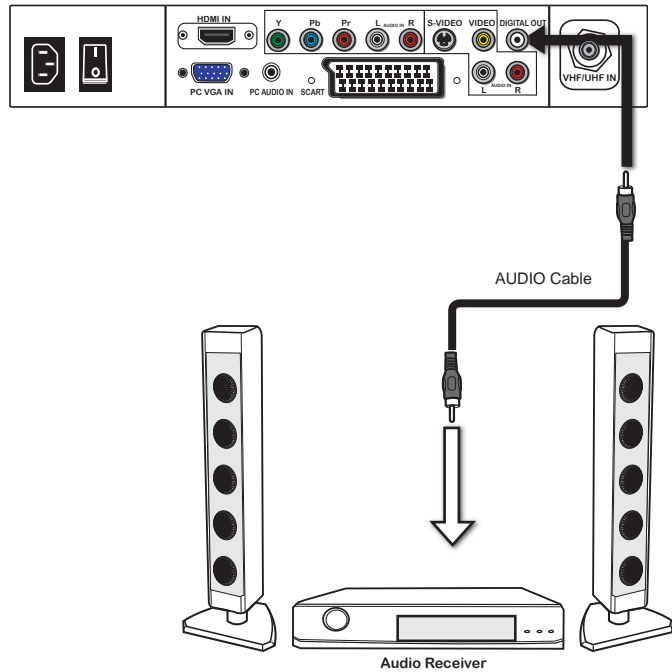



- 1 Use an audio cable to connect the audio receiver's audio LINE IN jacks to LCD TV's DIGITAL OUT jacks.
- 2 Connect all AC power sources, before turning on the power switch of the LCD TV or other connected equipment.
- 3 Press the  button on the remote to turn on the LCD TV.

Chapter 3

USING The OSD FEATURES

Operating the Menu

- 1 Press the  button to turn the LCD TV on.
- 2 Press the **MENU** button on the remote control, the on-screen menu will appear on the screen. Use the   buttons to select your main menu option.

PICTURE MENU:

Allows you to make adjustments to your picture settings.

- If the signal source is AV/S-VIDEO/YPbPr/SCART/HDMI, the Picture Menu appears as:
- If the signal source is TV/DTV, the Picture Menu appears as:

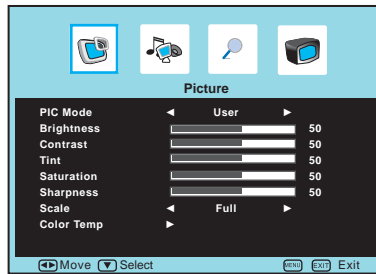
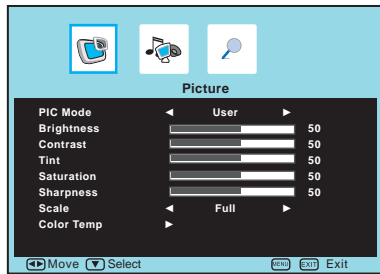

- If the signal source is VGA, the Picture Menu appears as:

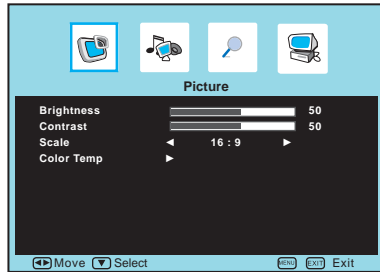

AUDIO MENU:

Allows you to customize the audio options and effects.

- If the signal source is AV/S-VIDEO/YPbPr/HDMI/SCART, the AUDIO Menu appears as:
- If the signal source is TV/DTV, the AUDIO Menu appears as:

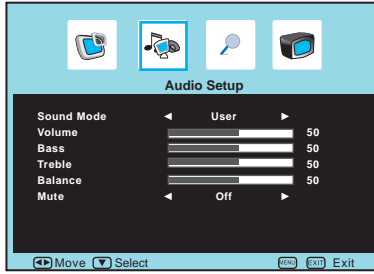
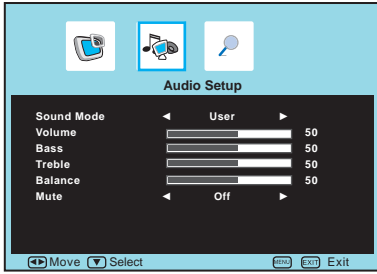

- If the signal source is VGA, the AUDIO Menu appears as:

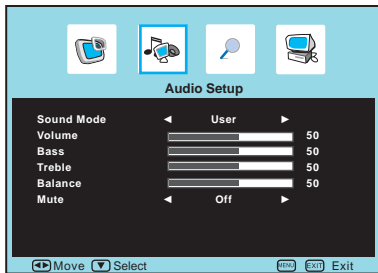

OSD SETUP MENU:

Allows you to set up a variety of features: Language, factory reset, sleep timer.

- If the signal source is AV/S-VIDEO/YPbPr/HDMI/SCART, the OSD Setup Menu appears as:
- If the signal source is TV/DTV, the OSD Setup menu appears as:

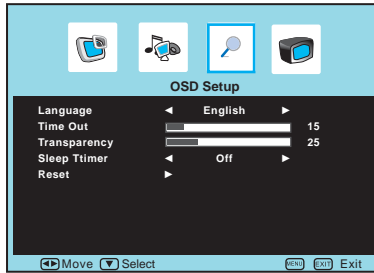
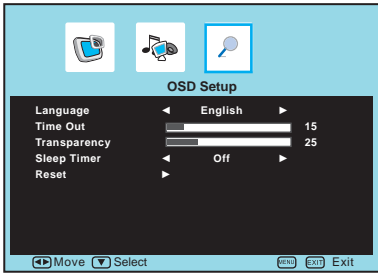

- If the signal source is VGA, the OSD Setup Menu appears as:

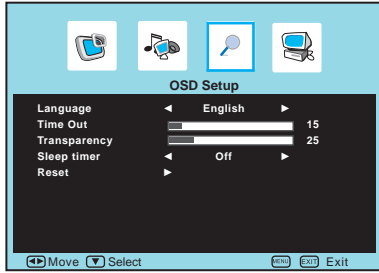

TV SETUP MENU:

Allows you to edit and label channels.

- If the signal source is TV, the TV Setup Menu appears as:
- If the signal source is DTV, the TV Setup Menu appears as:

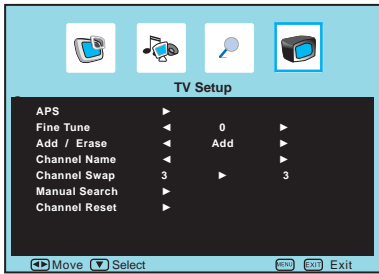

VGA SETUP MENU:

Allows you to setup the system function in VGA mode.

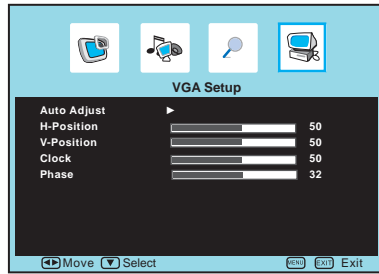

- 3 Use the ▲ ▼ buttons to select an option of the sub-menu, and press the OK button. While in adjustment mode, and use the ◀ ▶ buttons to change the value of the item.
- 4 Press the EXIT button to exit the menu.

Customizing the Picture Settings

- 1 Press the **POWER** button to turn the LCD TV on.
- 2 Press the **MENU** button on the remote control to display the Main menu, and use the **◀▶** buttons to select the **Picture**.
- 3 Use the **▲▼** buttons to highlight an individual Picture option, use the **◀▶** buttons to change the setting, and press the **MENU** to exit the menu
 - If the signal source is AV/S-VIDEO/YPbPr/SCART/HDMI, the Picture Menu appears as:
 - If the signal source is TV/DTV, the Picture Menu appears as:

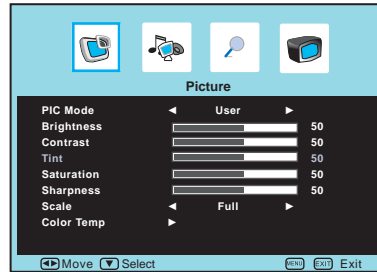
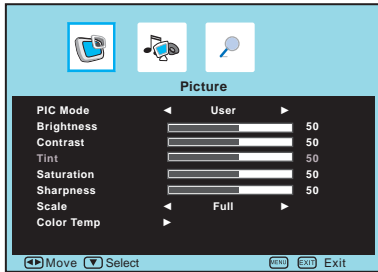

- If the signal source is VGA, the Picture Menu appears as:

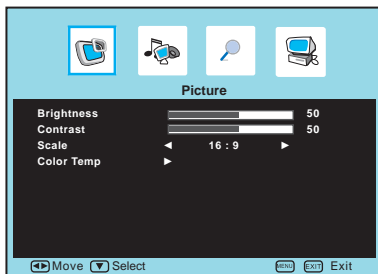

- 4 The **Picture** menu includes the following options:

PIC Mode	Cycles among display types: Movie/Vivid/Sport/Game/User
Contrast	Controls the difference between the brightest and darkest regions of the picture.
Brightness	Controls the overall brightness of the picture.
Tint	Controls the difference between the green and red regions of the picture.

-
- Saturation** Controls the colour intensity.
-
- Sharpness** Increase this setting to see crisp edges in the picture; decrease it for soft edges.
-
- Scale** Selects through Wide mode settings :
- In TV/AV/S-VIDEO/SCART mode: NORMAL /FULL/ZOOM1/ ZOOM2
 - In YPbPr/HDM mode, only 480i and 576i mode can be adjusted : NORMAL /FULL/ZOOM1/ZOOM2
 - In VGA/DVI mode, "Scale" function is not available
-
- Color Temp** Adjusts color components independently to achieve a warm or cool effect: Cool/Warm/User
- **Warm:** Increases red tint
 - **Cool:** Increases blue tint
 - **User:** Allows the user to adjust red, green and blue color component levels independently.

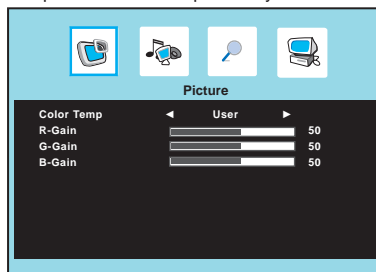

Customizing the AUDIO Settings

- 1 Press the **POWER** button to turn the LCD TV on.
- 2 Press the **MENU** button on the remote control to display the Main menu, and use the **◀▶** buttons to select the **AUDIO**.
- 3 Use the **▲▼** buttons to highlight an individual AUDIO option, use the **◀▶** buttons to change the setting, and press the **MENU** to exit the menu
 - If the signal source is AV/S-VIDEO/YPbPr/HDMI/SCART, the AUDIO Menu appears as:
 - If the signal source is TV/DTV, the AUDIO Menu appears as:

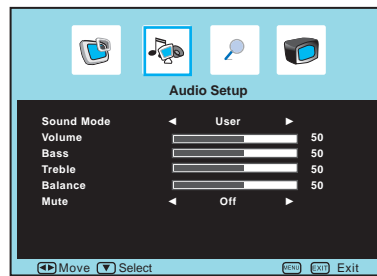
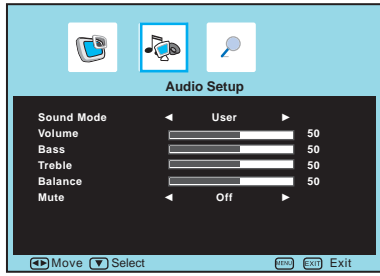

- If the signal source is VGA, the AUDIO Menu appears as:



- 4 The **AUDIO Setup** menu includes the following options:

Sound Mode	Allows selection of an audio-enhancement technique from among the following options: Live/POP/Rock/User.
Volume	Controls the volume.
Bass	Controls the relative intensity of lower-pitched sounds.
Treble	Controls the relative intensity of higher pitched sounds.
Balance	Adjusts the relative volume of the speakers in a multiple speaker system.
Mute	Allows you to mutes and restore your LCD TV sound.

Customizing the OSD SETUP Settings

- 1 Press the **POWER** button to turn the LCD TV on.
- 2 Press the **MENU** button on the remote control to display the Main menu, and use the **◀▶** buttons to select the **OSD SETUP**.
- 3 Use the **▲▼** buttons to highlight an individual OSD SETUP option, use the **◀▶** buttons to change the setting, and press the **MENU** to exit the menu.
 - If the signal source is AV/S-VIDEO/YpBPr/HDMI/SCART, the OSD Setup Menu appears as:
 - If the signal source is TV/DTV, the OSD Setup menu appears as:

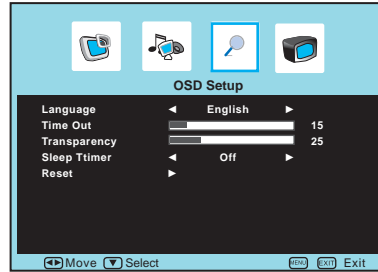
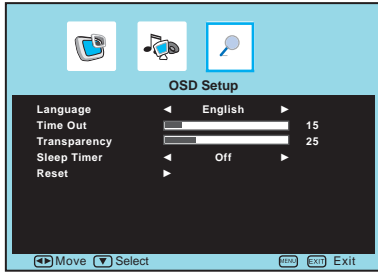

- If the signal source is VGA, the OSD Setup Menu appears as:

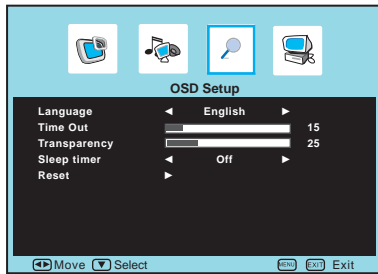

- 4 The **OSD SETUP** menu includes the following options:

Language	Selects to display all on-screen menus in your language of choice.
Time Out	Allows selection of the display time of the on-screen menu.
Transparency	Controls the translucence of the OSD on-screen menus's background.
Sleep Timer	Allows selection of the time that elapses before the TV shuts off automatically.
Reset	Restores factory settings.

Customizing the TV Settings

- 1 Press the **POWER** button to turn the LCD TV on.
- 2 Press the **MENU** button on the remote control to display the Main menu, and use the **◀▶** buttons to select the **TV Setup**.
- 3 Use the **▲▼** buttons to highlight an individual TV Setup option, use the **◀▶** buttons to change the settings, and press the **MENU** exits the menu.
 - If the signal source is TV, the TV Setup Menu appears as:
 - If the signal source is DTV, the TV Setup Menu appears: For more information on DTV Services, please see the "Using the DTV Features" section.

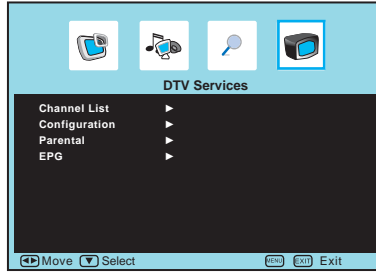
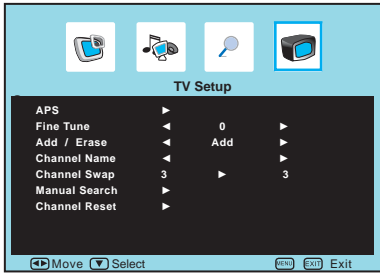

- 4 The **TV Setup** menu includes the following options:

APS

- 1 Press the **OK** button to display the Start APS menu:

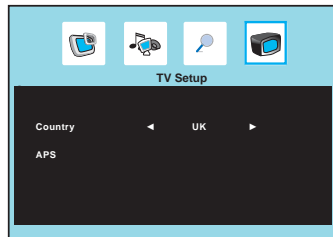

- 2 Press the **◀▶** buttons to select the country.
Country: Allows you select the country: UK, Ireland, Denmark, Finland, Italy, Norway, Spain, Sweden, Luxemburg, France, Czech., Poland, Hungary, Austria, Germany, Switzerland, Belgium, Netherlands, other.
- 3 Press the **▲▼** buttons to select APS, Then select "YES" to start auto search and auto sort process.

Fine Tune	Allows adjustment for the fine tune level by hand if signal is too weak or picture is blurry.
Add/Erase	Allows addition/removal of channels on the channel list.
Channel Name	Allows channel labels to be edited. Use the ▼▲◀▶ buttons to select the characters (maximum of 5 characters).
Channel Swap	Allows you to change the TV station channel location.
Manual Search	Allows you to choose the channels that you like.
Channel Reset	Allows you to restore default settings.

Customizing the VGA Settings

- 1 Press the **POWER** button to turn the LCD TV on.
- 2 Press the **MENU** button on the remote control to display the Main menu, and use the **◀▶** buttons to select the **VGA Setup**.
- 3 Use the **▲▼** buttons to highlight an individual VGA Setup option, use the **◀▶** buttons to change the setting, and press the **MENU** to exit the menu

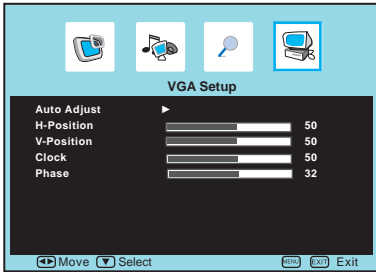

- 4 The **VGA Setup** menu includes the following options:

Auto Adjust	Press the OK button to automatically adjust the display settings to optimize performance based on the VGA mode.
H-Position	Adjusts the position of the picture left and right in the window.
V-Position	Adjusts the position of the picture up and down in the window.
Clock	Controls the width of the picture based on the VGA mode.
Phase	Controls the signal phase, which can improve focus clarity and image stability based on the VGA mode.

Chapter 4

USING THE DTV FEATURES

Operating the Menu

- 1 You can set the digital TV setting, press the **INPUT** button on the remote to display the Source List. Use the **▲▼** buttons to select **DTV**, and press the **OK** button.
- 2 Press the **MENU** button on the remote control, the on-screen menu will appear on the screen. Use the **▶** buttons to select **DTV Services**:



- 3 Use the **▲▼** buttons to highlight an individual DTV Services option, use **▶** or **OK** to display the sub-menu.

Channel List Menu:



Channel List Menu:

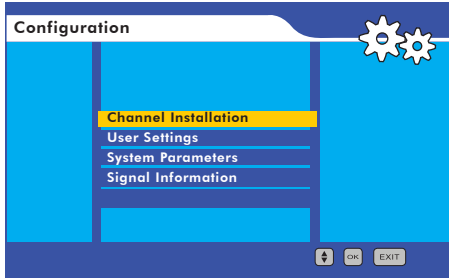

ENGLISH

Parental Control Menu:

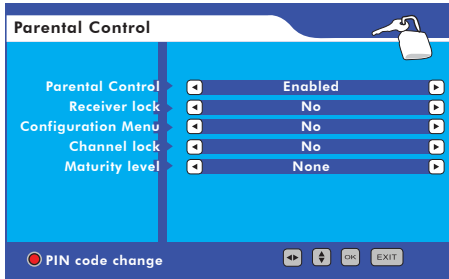

EPG Menu:



 The DTV features may not be available in some countries.

Customizing the Channel List Settings

The Channel List feature allows you to select programs from a list you specify.

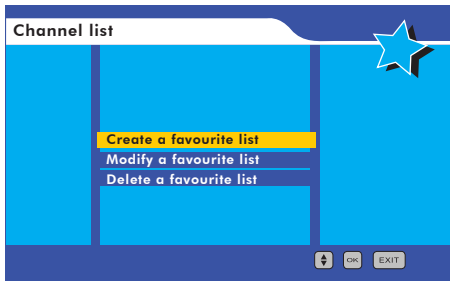

The Channel List menu includes the following options:

Create a favorite list

- 1 Press the **▲▼** buttons to highlight the Create a Favorite list and press **OK** to display the menu:



- 2 Press the **▲▼** buttons to highlight the channel you want to select, and press the green button repeatedly to select skip or add (✓) the selected channel.

Modify a favorite list

- 1 Press the ▲▼ buttons to highlight the Modify a Favorite list and press OK to display the menu:



- 2 Use the ▲▼ buttons to highlight the channel you want to modify and press the Red button repeatedly to select LOCK(●) or UNLOCK.
- 3 Press OK to appear a message to confirm that you want to lock the channel from the Favorite list.

Delete a favorite list

- 1 Press OK to appear a message to confirm that you want to delete all channels from the Favorite list.

Customizing the Configuration Settings

The Configuration feature allows you to add new channels, set audio or subtitle languages, set the time, and view system and signal information.

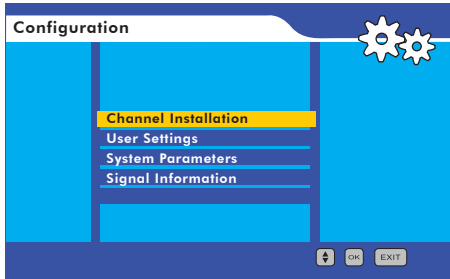

The Configuration menu includes the following options:

Channel Installation

Press the ▲▼ buttons to highlight the Channel Installation and press **OK** to display the menu:

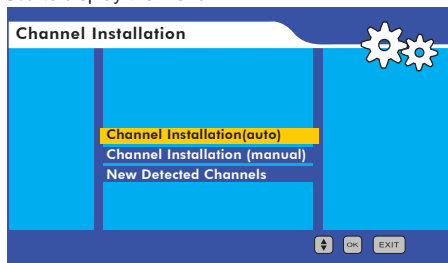

- **Channel Installaion(auto):**
 - ❶ Use ◀▶ buttons to select "ADD", the new channels will be added in the channel list.
 - ❷ Use ◀▶ buttons to select "NEW", the new channels will be replaced the previous channels in the channel list.
- **Channel Installaion(manual):**

Allows to create channels manually.
- **New Detected Channels:**

Press **OK** to display the New Detected Channels menu, shows the channels that you add in the channels list recently.

System Parameters

Press the ▲▼ buttons to highlight the System Parameters and press **OK** to display the menu:

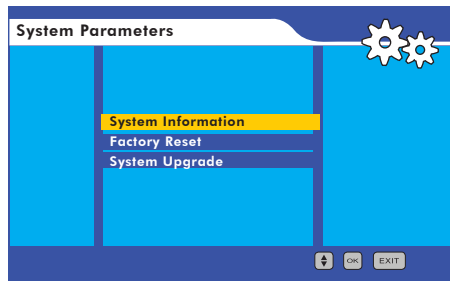

- **System Information:**
Press **OK** to display the system information menu
- **Factory Reset:**
Use to select "Yes" and press **OK** to restore factory Reset.
- **System Upgrade:**
Press **OK** to upgrade system.

Signal Information

Press the ▲▼ buttons to highlight the Signal Information and press **OK** to display the menu. Allows you to view the signal strength and quality of the channel.

Customizing the Parental Control Settings

The Parental Control feature allows you to set up the TV to block programs according to the content and rating levels.

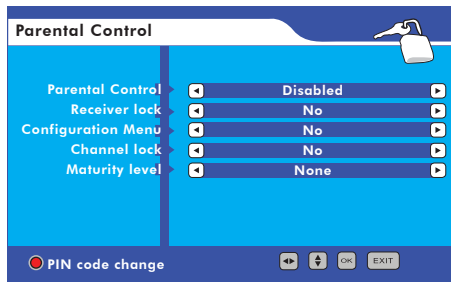

The **Parental Control** menu includes the following options:

Parental Control	<ol style="list-style-type: none"> Press the ◀▶ buttons to select "Enabled", and press OK. Use the Parental Control function, must enter a four-digit pin code. The Factory pin code is 0000. Press the RED buttons to change your pin code.
Receiver lock	Press the ◀▶ buttons to select "Yes", allow to view the DTV program while TV is powered on and select the DTV source by entering the pin code.
Configuration Menu	Press the ◀▶ buttons to select "Yes", allow to set up the Configuration menu by entering the pin code.
Channel lock	Press the ◀▶ buttons to select "Yes", allow to view the DTV Channel List by entering the pin code.
Maturity level	Press the ◀▶ buttons to set up an age restriction for programmes, Any programme that exceeds the age restriction can only be watched by entering the pin code.

Using the DTV OSD Settings

PROGRAM INFORMATION

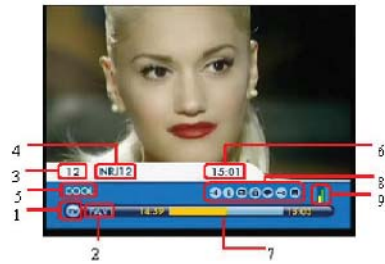

Banner details

After each channel change or after a press on the INFO button, a banner is displayed at the bottom of the screen for a few seconds, including service type (1), current list (2), channel number in the list (3), channel name (4), event name (5), current time (6), event duration bargraph with start and stop times (7) as well as specific icons relative to the service properties (8) (from left to right: maturity level, extended event information / Teletext presence / service locked / multitrack audio / scrambled program / Subtitle presence) and signal strength and quality indicators (9).

EPG

EPG (Electronic Programme Guide) menu is reached by pressing GUIDE button, quit by pressing GUIDE button again. Current program is highlighted. Use Channel Up/Down ▲/▼ buttons to change channels and view the other programmes on the selected channel. Press the Arrow up / Arrow down navigation buttons to scroll through and show programme content. There is a 7day EPG, you can see the other days channel list by using Left / right navigation arrow ◀/▶ buttons.

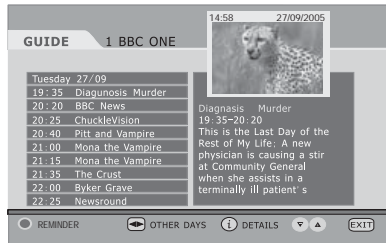

The short description of the highlighted channel is shown under the image window, and you can see the extended description by pressing the INFO or OK button and by pressing this button again you can close this window. Press the "RED" button to set a reminder from the program, press the "RED" button again to cancel the reminder.

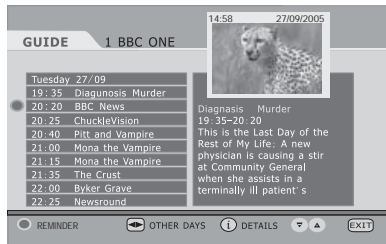

TROUBLESHOOTING



Before consulting service personnel, check the following chart for a possible cause of problem and for a possible solution.

TV will not turn on

- 1 Make sure the power cord is plugged in, then press the  button on the remote.
- 2 Make sure the AC switch on the rear of the TV is turned on.
- 3 The batteries in the remote control may be exhausted. Replace the batteries.

No picture, no sound

- 1 Check the interface cable between TV and antenna/cable TV.
- 2 Press the  button on the remote.
- 3 Press the **INPUT** button on the remote repeatedly to select the connected video sources.

Poor picture, sound OK

- 1 Check the interface cable between TV and antenna/cable TV.
- 2 Try another channel, the station may have broadcast difficulties.
- 3 Adjust the Brightness/Contrast options in the **VIDEO** Menu.

Picture OK, poor sound

- 1 Sound may be muted. Press the  button on the remote.
- 2 Press the **VOL+** button to increase the volume.
- 3 Check Audio Settings (see section entitled "Customizing the AUDIO Settings").

Audio noise

- 1 Move any infrared equipment away from the TV.

SPECIFICATIONS

ENGLISH

MODEL		
LCD Panel	Panel Size	20.1" TFT LCD
	Brightness	300
	Contrast Ratio	1000:1
Max. Resolution		1680 x 1050
Input Connector	C-VIDEO/ S-VIDEO/ AUDIO IN(L/R)	1
	YPbPr/ AUDIO IN(L/R)	1
	SCART	1
	PC VGA IN	1
	HDMI IN	1
	PC AUDIO IN	1
	DIGITAL OUT	1
	HEADPHONE	1
	VHF/UHF IN	1
	Power Source	
Power Consumption		60 W, Standby < 3 W
Dimension		44.2w x 48.8h x 20.2d cm
Weight		6.8kg



Questions? Need some help?

Call our free-phone number found on the insert with this icon:



Or visit www.polaroid.com.