

Libro de instrucciones
51 8027
(E,F,GB,P)

1) 28 8384

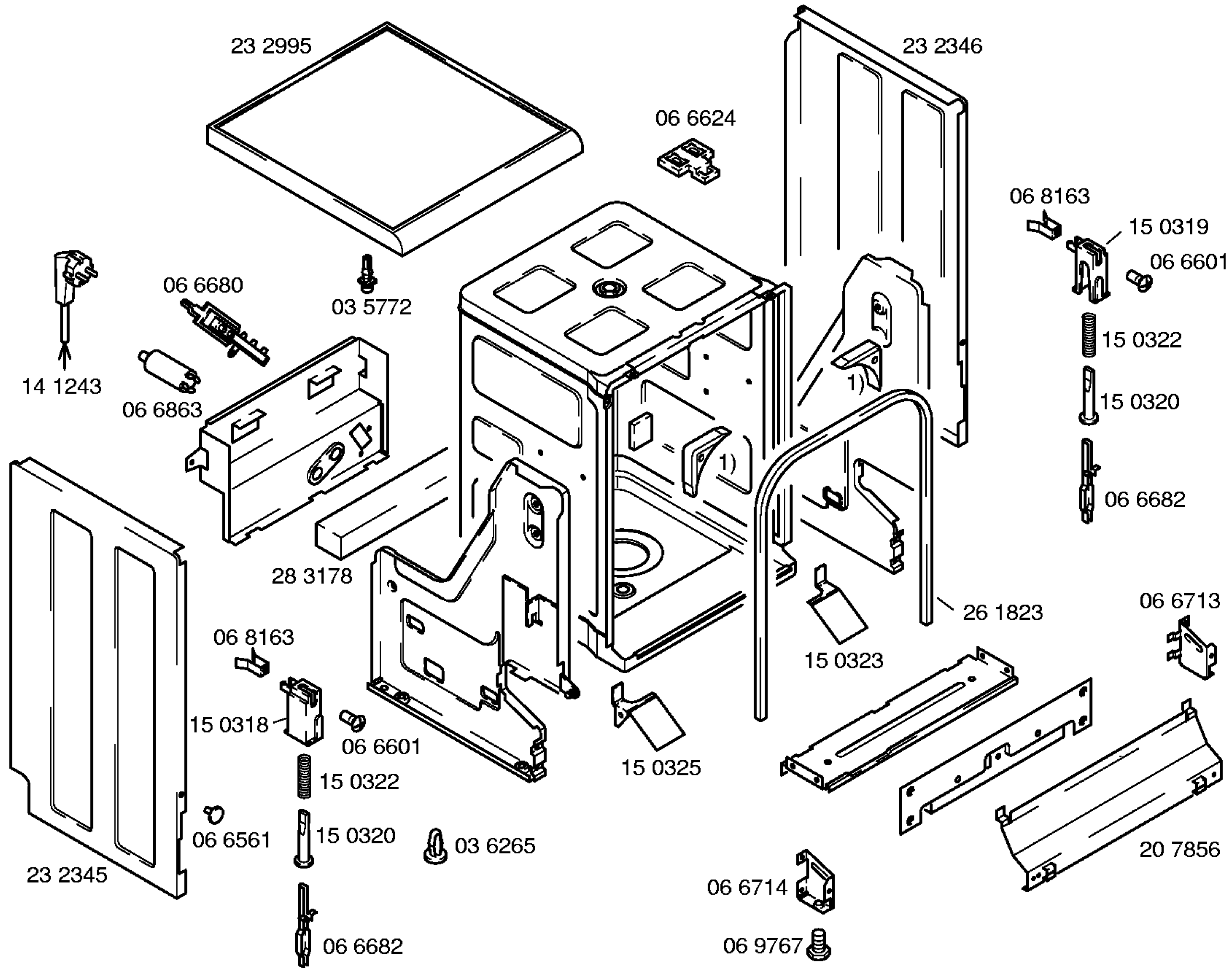

1) 16 2550

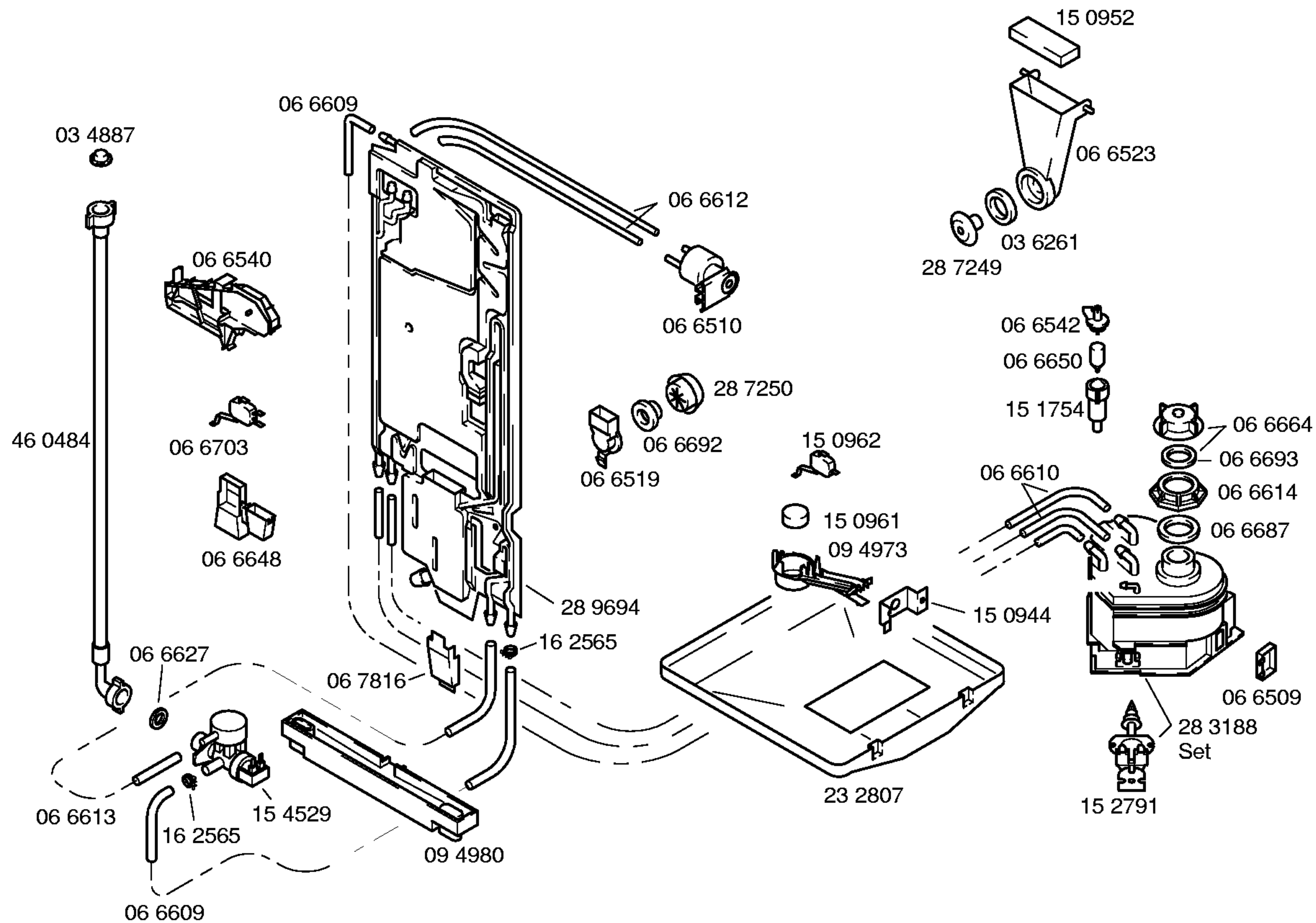

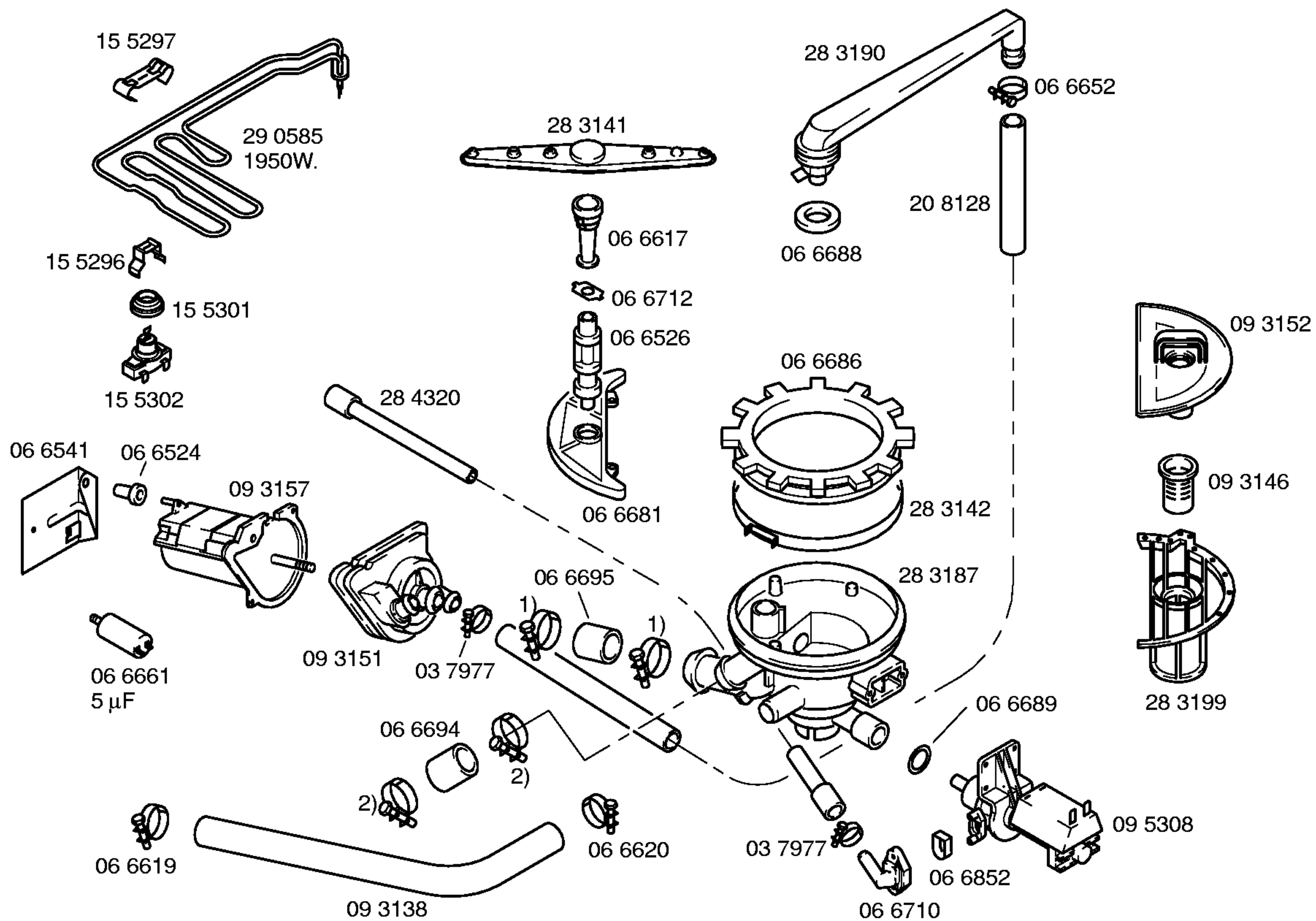

- 1) 06 6621
- 2) 06 6622

