

Libro de instrucciones
51 8239
(E,F,GB,P)

1) 29 7648

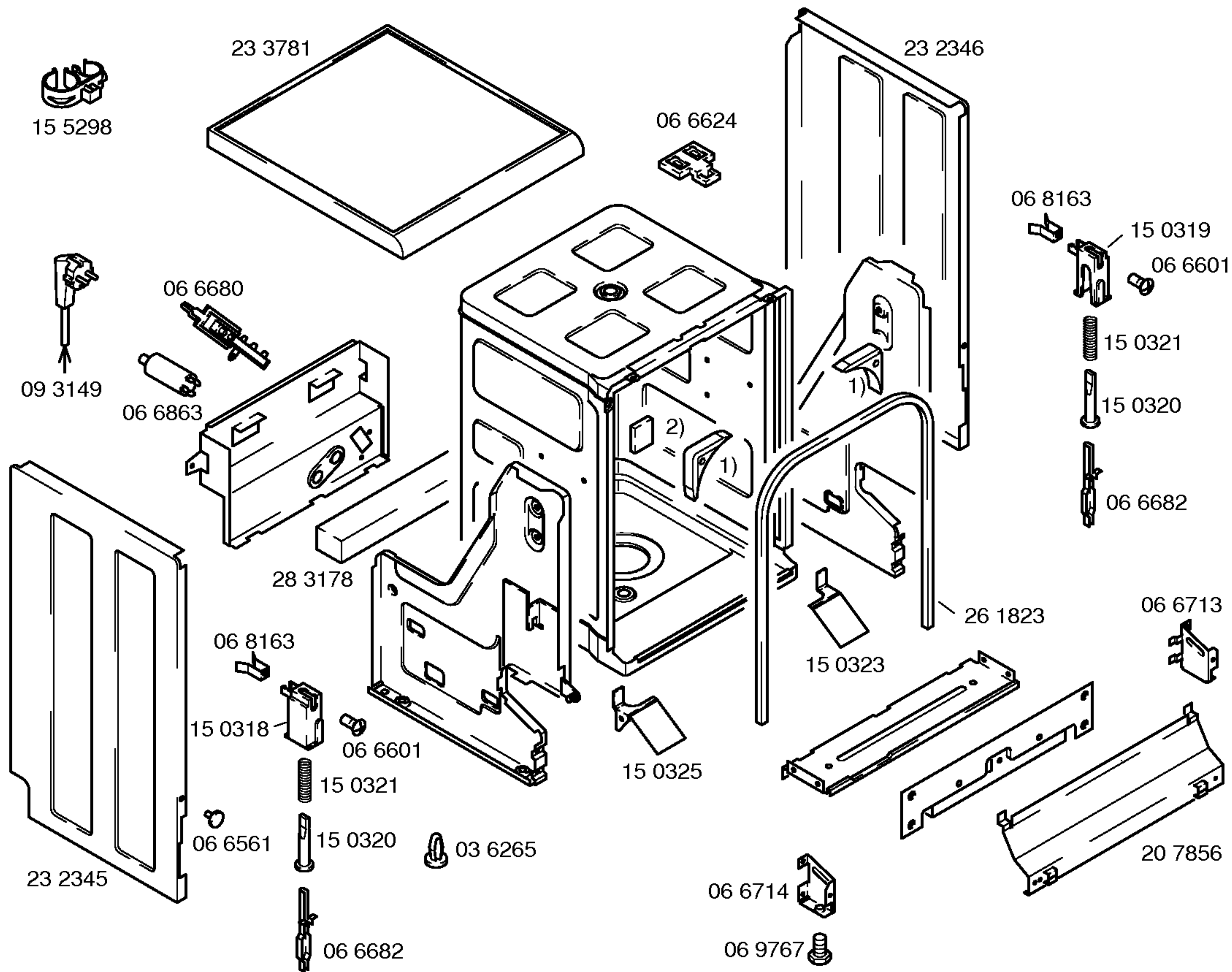

1) 16 2550
2) 06 6569

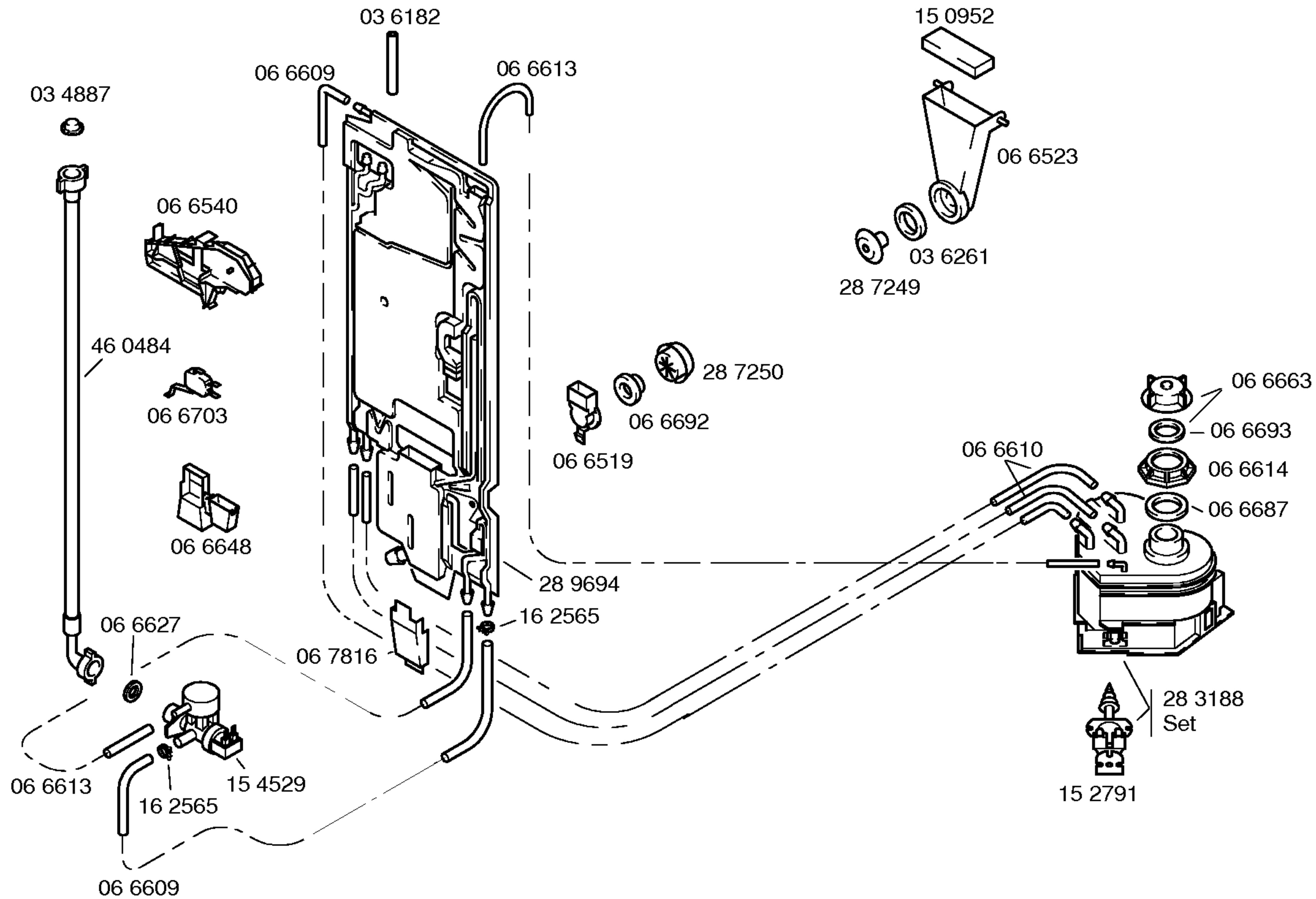

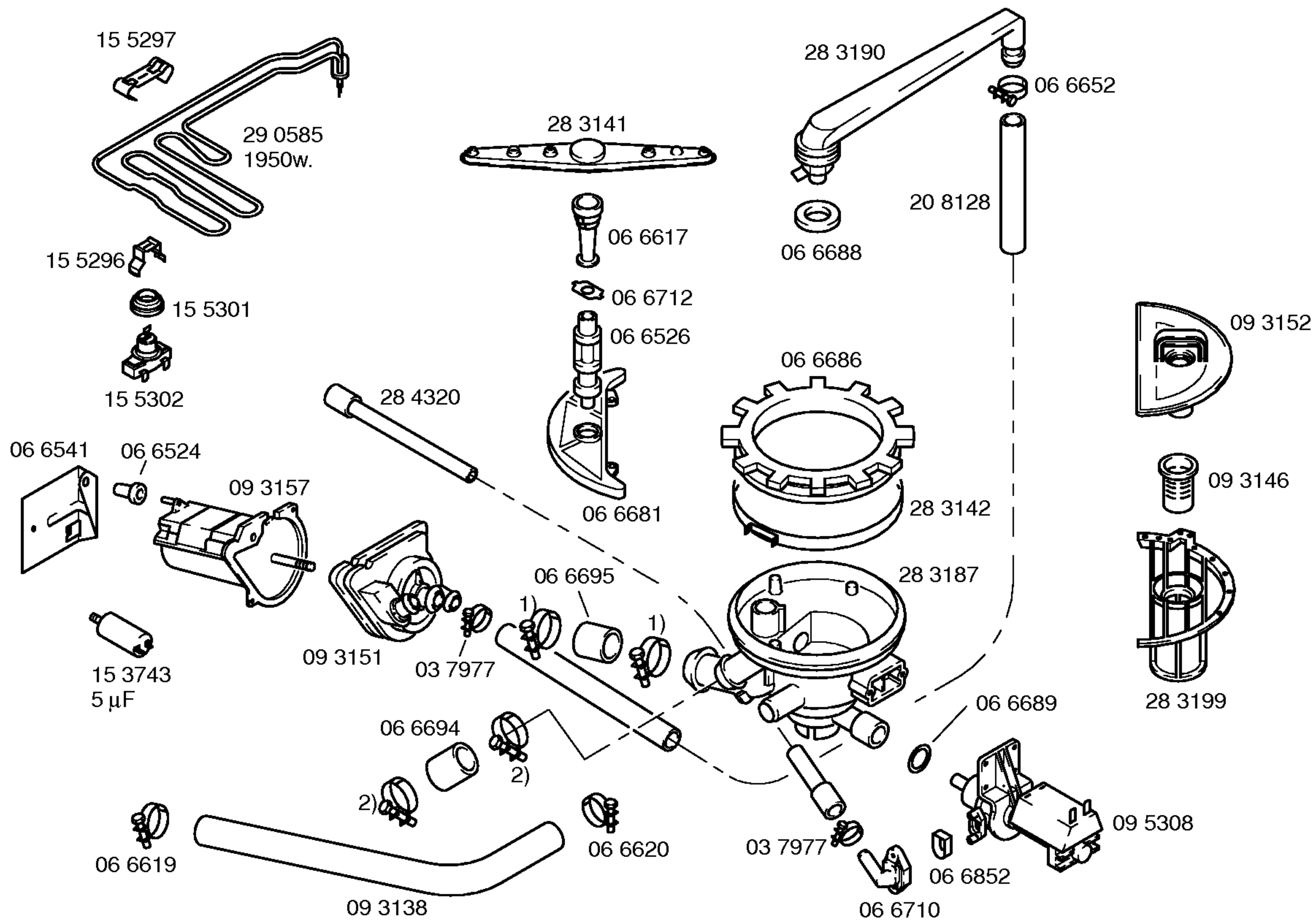

- 1) 06 6621
- 2) 06 6622

